

Area		JAPAN	NORTH AMERICA	LATIN AMERICA	EUROPE	GENERAL AREA + IN5 stand models	CHINA	IN5 Stand-less
Model Name		K-65XR80	K-65XR80	K-65XR80	K-65XR80	K-65XR80	K-65XR80	K-65XR80
SV No.		SV-42134	SV-42109	SV-42120	SV-42125	SV-42197	SV-42218	SV-42151
DIMENSION	TV only (W x H x D)	144.2 x 82.9 x 3.7 cm	1442 x 829 x 37 mm / 56 7/8 x 32 3/4 x 1 1/2 inch	1442 x 829 x 37 mm	Approx. 144.2 x 82.9 x 3.7 cm	Approx. 1442 x 829 x 37 mm	Approx. 1442 x 829 x 37 mm	Approx. 1442 x 829 x 37 mm
	TV only with camera (W x H x D)	-	-	-	-	-	-	-
	TV with Stand (Outside) (W x H x D)	144.2 x 85.5 x 24.8 cm	1442 x 855 x 248 mm / 56 7/8 x 33 3/4 x 9 7/8 inch	1442 x 855 x 248 mm	Approx. 144.2 x 85.5 x 24.8 cm	Approx. 1442 x 855 x 248 mm	Approx. 1442 x 855 x 248 mm	-
	TV with Stand (Inside) (W x H x D)	144.2 x 85.5 x 24.8 cm	1442 x 855 x 248 mm / 56 7/8 x 33 3/4 x 9 7/8 inch	1442 x 855 x 248 mm	Approx. 144.2 x 85.5 x 24.8 cm	Approx. 1442 x 855 x 248 mm	Approx. 1442 x 855 x 248 mm	-
	TV with Stand (Outside for Soundbar) (W x H x D)	144.2 x 90.9 x 24.8 cm	1442 x 909 x 248 mm / 56 7/8 x 35 7/8 x 9 7/8 inch	1442 x 909 x 248 mm	Approx. 144.2 x 90.9 x 24.8 cm	Approx. 1442 x 909 x 248 mm	Approx. 1442 x 909 x 248 mm	-
	TV with Stand (Inside for Soundbar) (W x H x D)	144.2 x 90.9 x 24.8 cm	1442 x 909 x 248 mm / 56 7/8 x 35 7/8 x 9 7/8 inch	1442 x 909 x 248 mm	Approx. 144.2 x 90.9 x 24.8 cm	Approx. 1442 x 909 x 248 mm	Approx. 1442 x 909 x 248 mm	-
	TV with Stand (Front position style) (W x H x D)	-	-	-	-	-	-	-
	TV with Stand (Back position style) (W x H x D)	-	-	-	-	-	-	-
	TV with Floor Stand (W x H x D)	-	-	-	-	-	-	-
	Stand Width (Outside)	124.4 cm	1244 mm / 49 inch	1244 mm	Approx. 124.4 cm	Approx. 1244 mm	Approx. 1244 mm	-
	Stand Width (Inside)	58.4 cm	584 mm / 23 inch	584 mm	Approx. 58.4 cm	Approx. 584 mm	Approx. 584 mm	-
	Stand Width (Outside for Soundbar)	124.4 cm	1244 mm / 49 inch	1244 mm	Approx. 124.4 cm	Approx. 1244 mm	Approx. 1244 mm	-
	Stand Width (Inside for Soundbar)	58.4 cm	584 mm / 23 inch	584 mm	Approx. 58.4 cm	Approx. 584 mm	Approx. 584 mm	-
	Stand Width (Front position style)	-	-	-	-	-	-	-
	Stand Width (Back position style)	-	-	-	-	-	-	-
	Floor Stand Width	-	-	-	-	-	-	-
	VESA Hole Pitch	30.0 x 30.0 cm	300 x 300 mm / 11 7/8 x 11 7/8 inch	300 x 300 mm	30.0 x 30.0 cm	300 x 300 mm	300 x 300 mm	300 x 300 mm
WEIGHT	TV Only	22.3 kg	22.3 kg / 49.2 lb	22.3 kg	Approx. 22.3 kg	Approx. 22.3 kg	Approx. 22.3 kg	Approx. 22.3 kg
	TV with Stand (Outside)	23.2 kg	23.2 kg / 51.2 lb	23.2 kg	Approx. 23.2 kg	Approx. 23.2 kg	Approx. 23.2 kg	-
	TV with Stand (Inside)	23.2 kg	23.2 kg / 51.2 lb	23.2 kg	Approx. 23.2 kg	Approx. 23.2 kg	Approx. 23.2 kg	-
	TV with Stand (Outside for Soundbar)	23.2 kg	23.2 kg / 51.2 lb	23.2 kg	Approx. 23.2 kg	Approx. 23.2 kg	Approx. 23.2 kg	-
	TV with Stand (Inside for Soundbar)	23.2 kg	23.2 kg / 51.2 lb	23.2 kg	Approx. 23.2 kg	Approx. 23.2 kg	Approx. 23.2 kg	-
	TV with Stand (Front/Back position style)	-	-	-	-	-	-	-
	TV with Floor Stand	-	-	-	-	-	-	-
	Floor Stand weight (Supply)	-	-	-	-	-	-	-
	W-M't Br. Weight (Supply)	-	-	-	-	-	-	-
Remarks		4 WAY	4 WAY	4 WAY	4 WAY	4 WAY	4 WAY	-

WITH STAND  
OUTSIDE

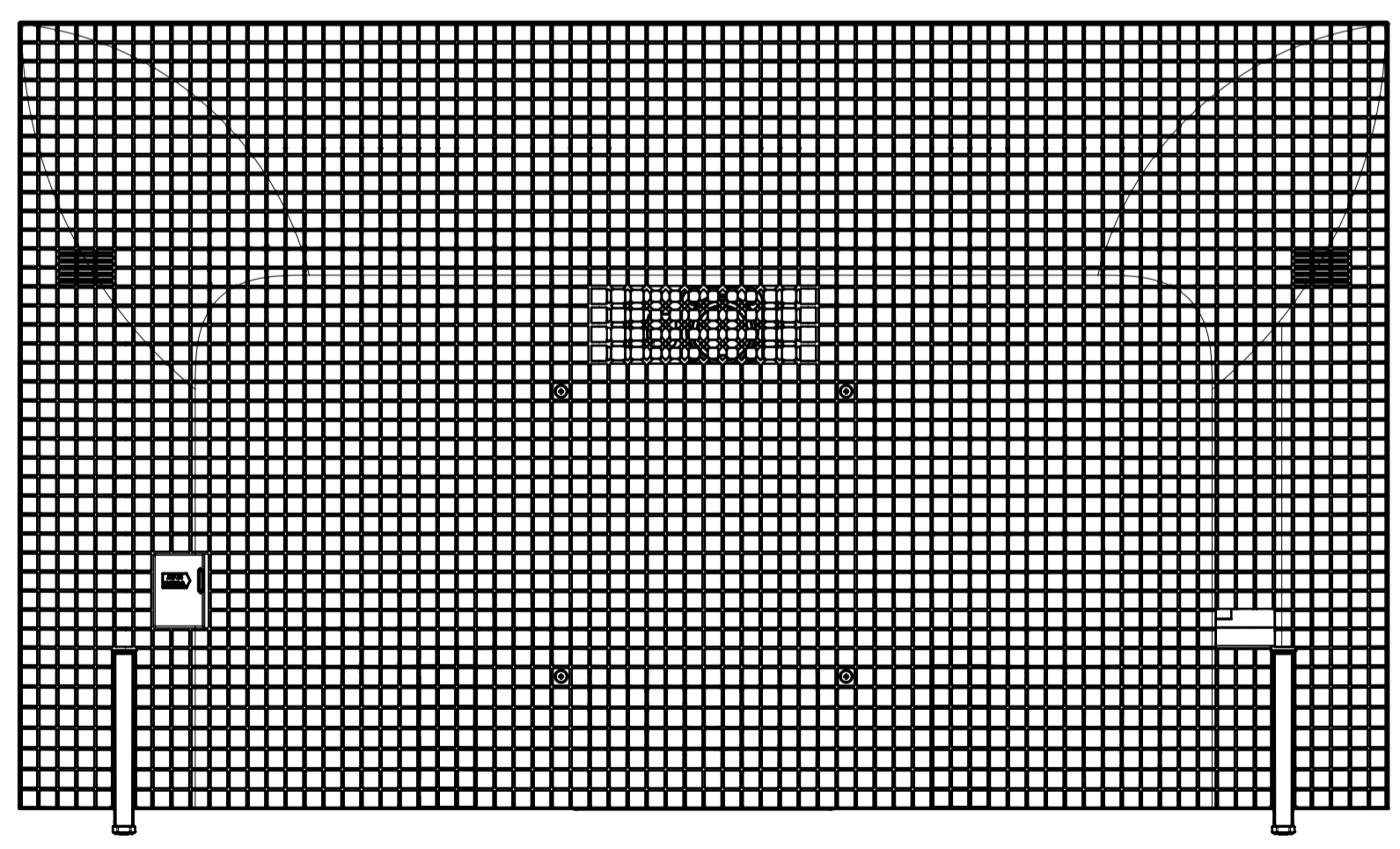
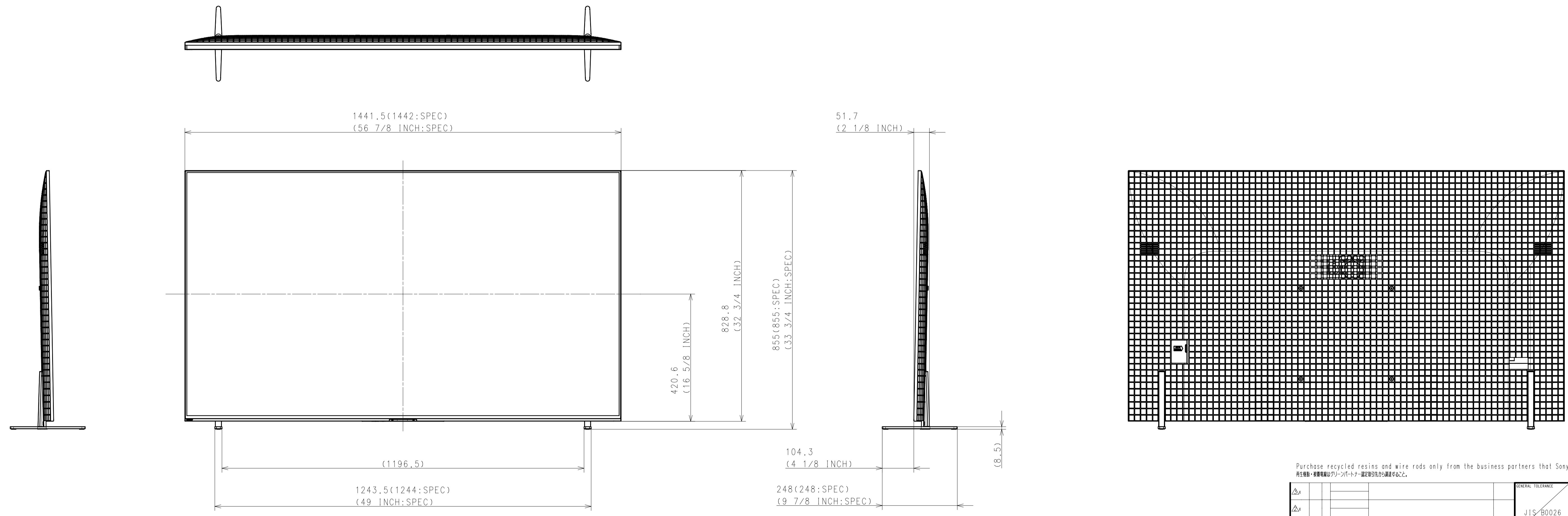

Purchase recycled resins and wire rods only from the business partners that Sony approves as Green Partners.  
再生樹脂・銅線材はグリーンパートナー認定受注先から調達すること。

△A				GENERAL TOLERANCE	DATE OF ISSUE
△B					2023.11.23
△C					DOCUMENT TYPE
△D				JIS-B0026	PART
△E				JIS010579-NR	DRAWING
HISTORY	SUFFIX	RELEASE NO.	DATE	REVISION	SIGN.
1		2024.02.16		Pgl weight revision at Japan column	syed
LEGAL OWNER	Sony Corporation				
RESPONSIBLE DEPARTMENT	PANEL & MECHANICAL DESIGN		ORIGINAL MODEL	DESCRIPTION	
PLANNED BY	2023.11.23	DESIGNED BY	2023.11.23	SCALE	1:7
DRAWN BY	2023.11.23	APPROVED BY	2023.11.23	TENTATIVE MODEL	65 (XR80) EXTERIOR VIEW
				PRELIMINARY	65 (XR80) EXTERIOR VIEW
				SIZE	A1
				UNIT	mm
				PART NO.	SUFFIX
				REV. NO.	1/8
				SHEET/PAGES	

WITH STAND

OUTSIDE FOR  
SOUNDBAR

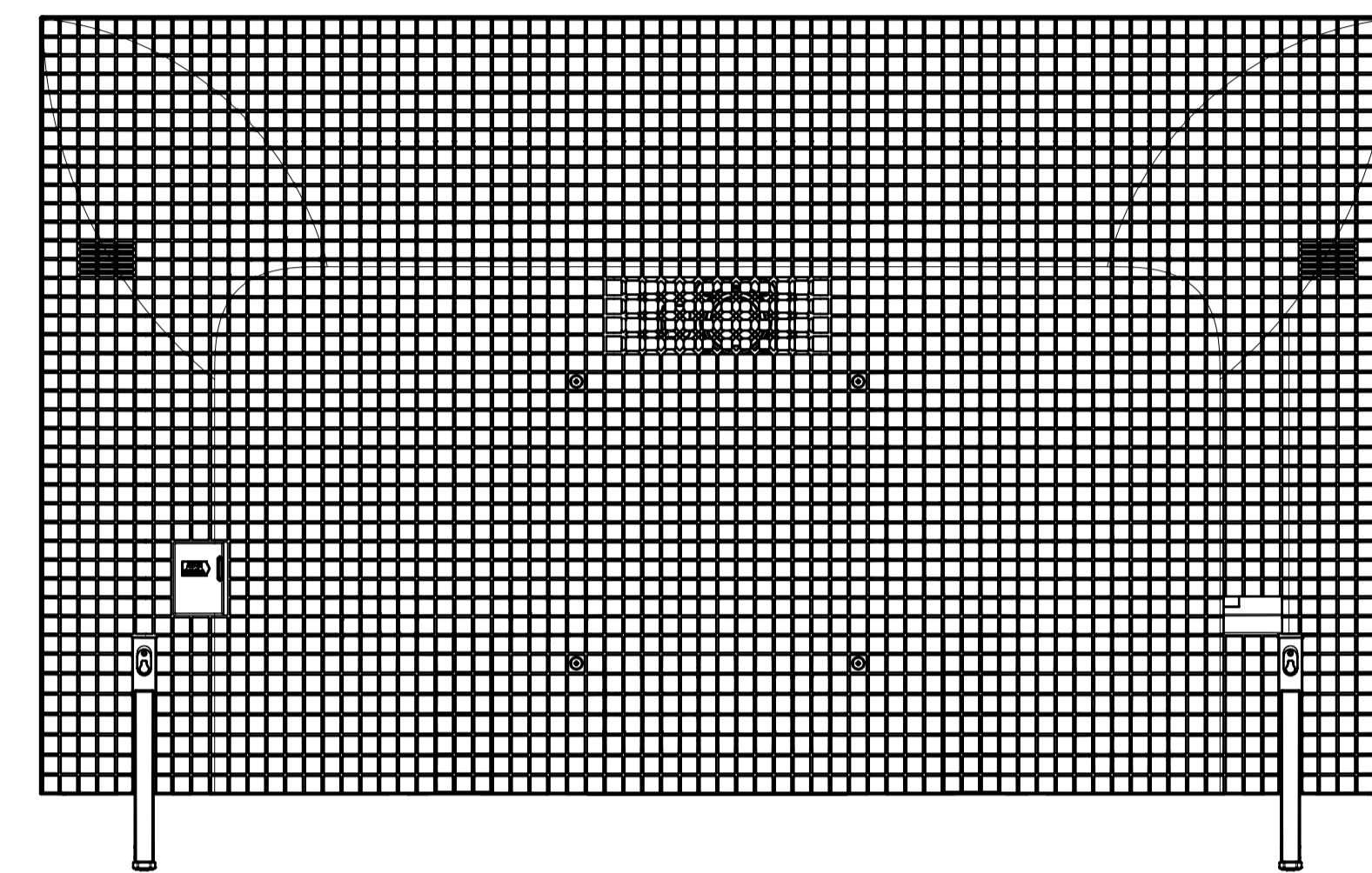
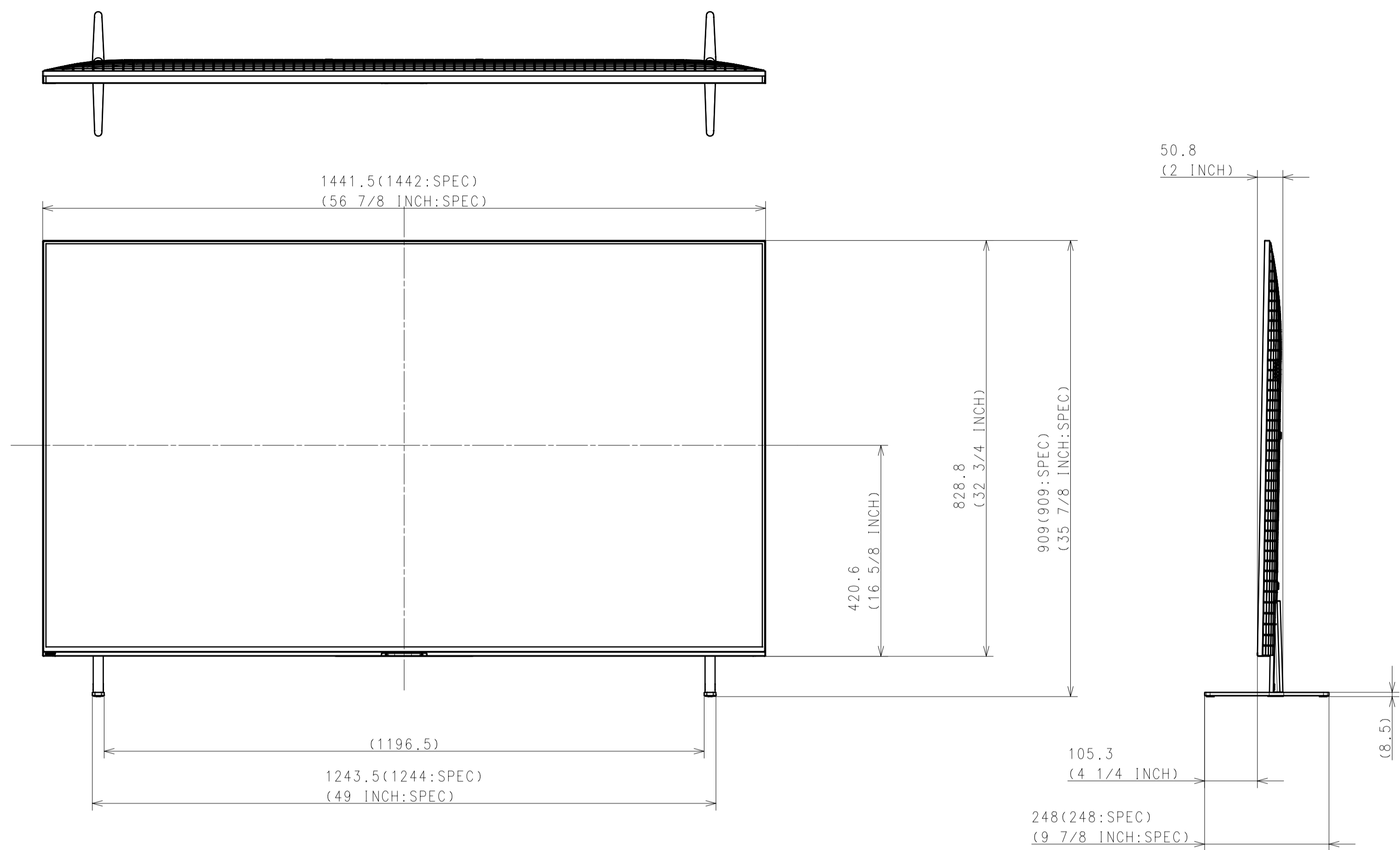
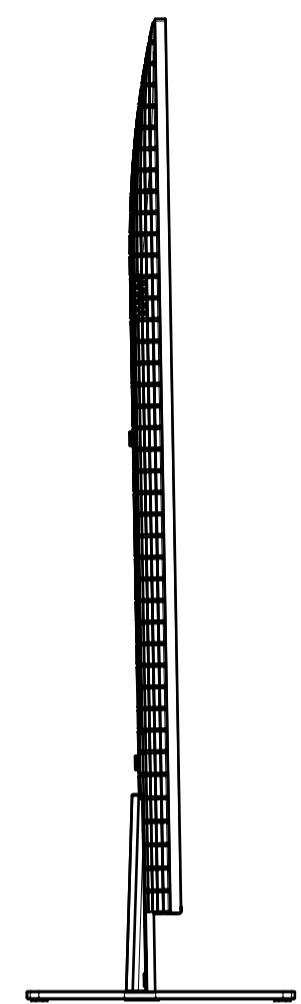

WITH STAND

INSIDE

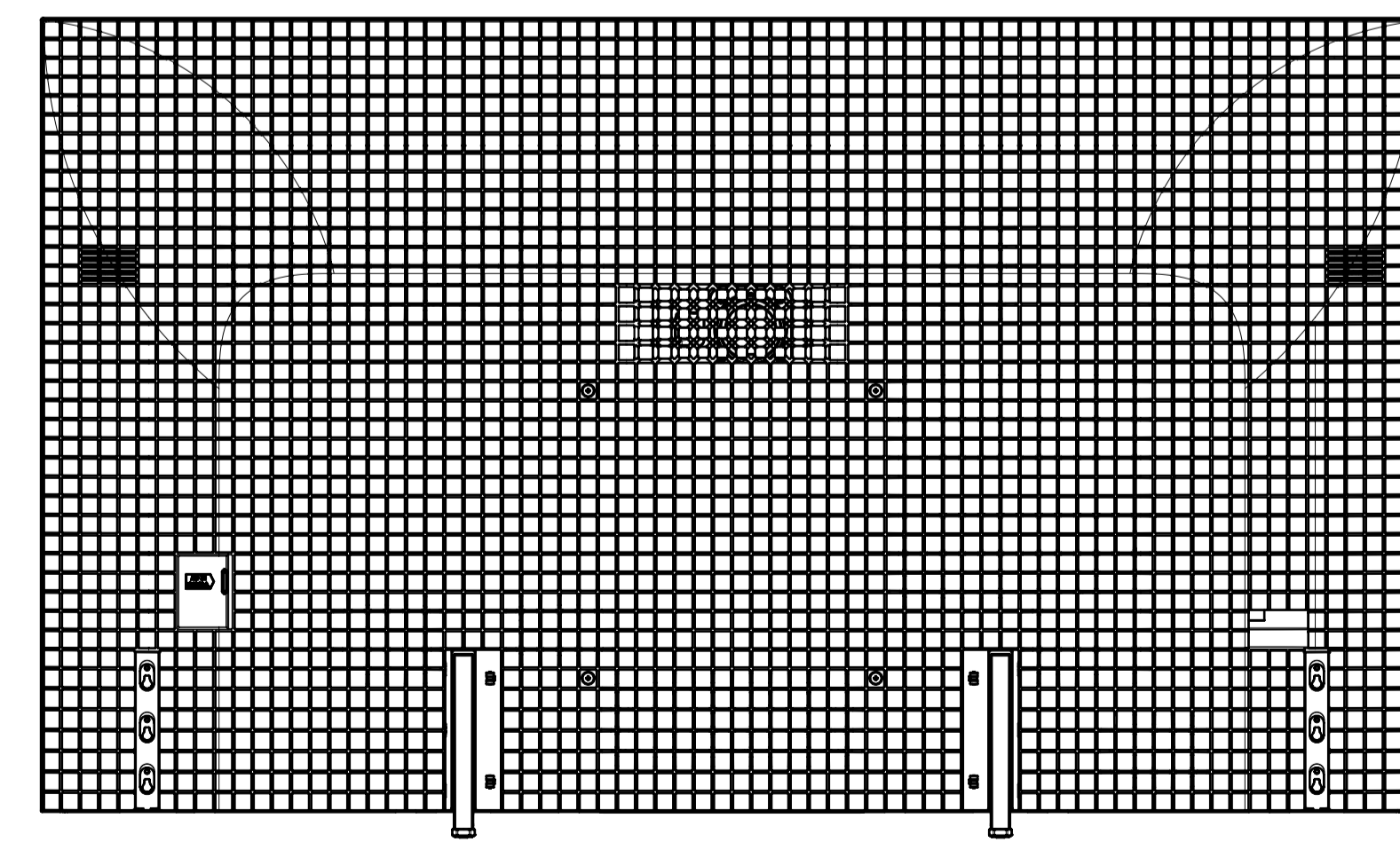
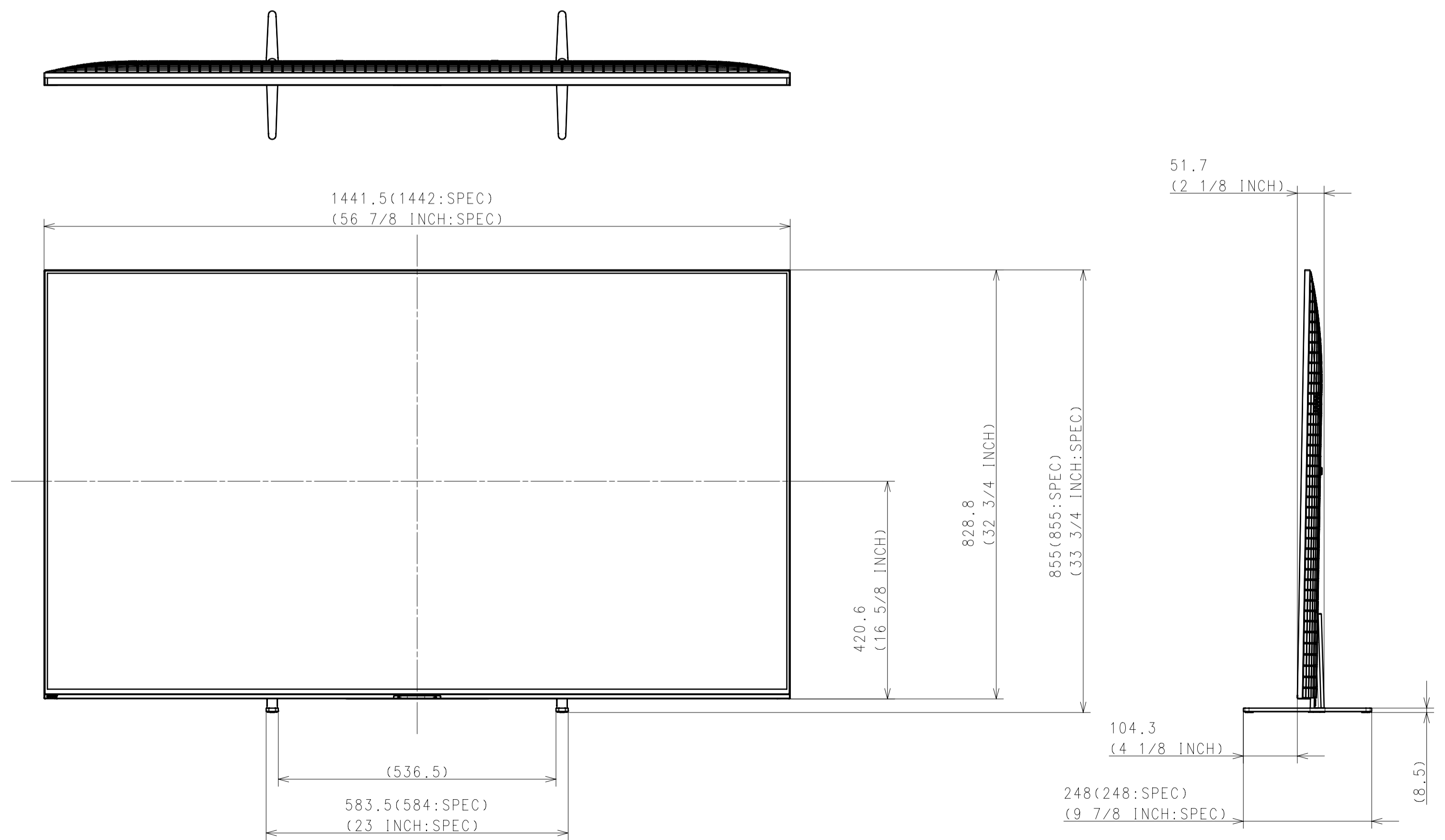
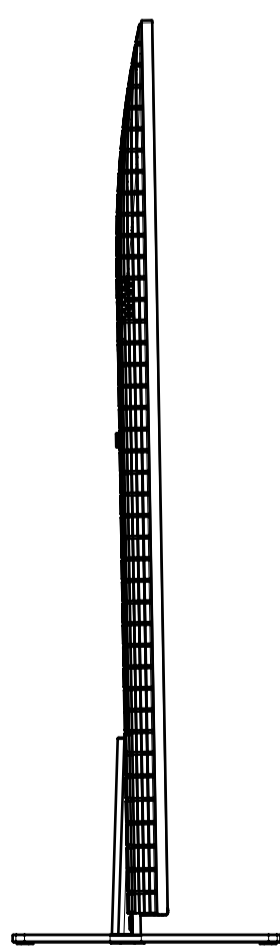

DESCRIPTION 1	LEGAL OWNER	SCALE
65 (XR80) EXTERIOR VIEW	Sony Corporation	1:1
DESCRIPTION 2	PART NO.	SHEET/PAGES
65 (XR80) EXTERIOR VIEW		2 / 8

WITH STAND

INSIDE FOR  
SOUNDBAR

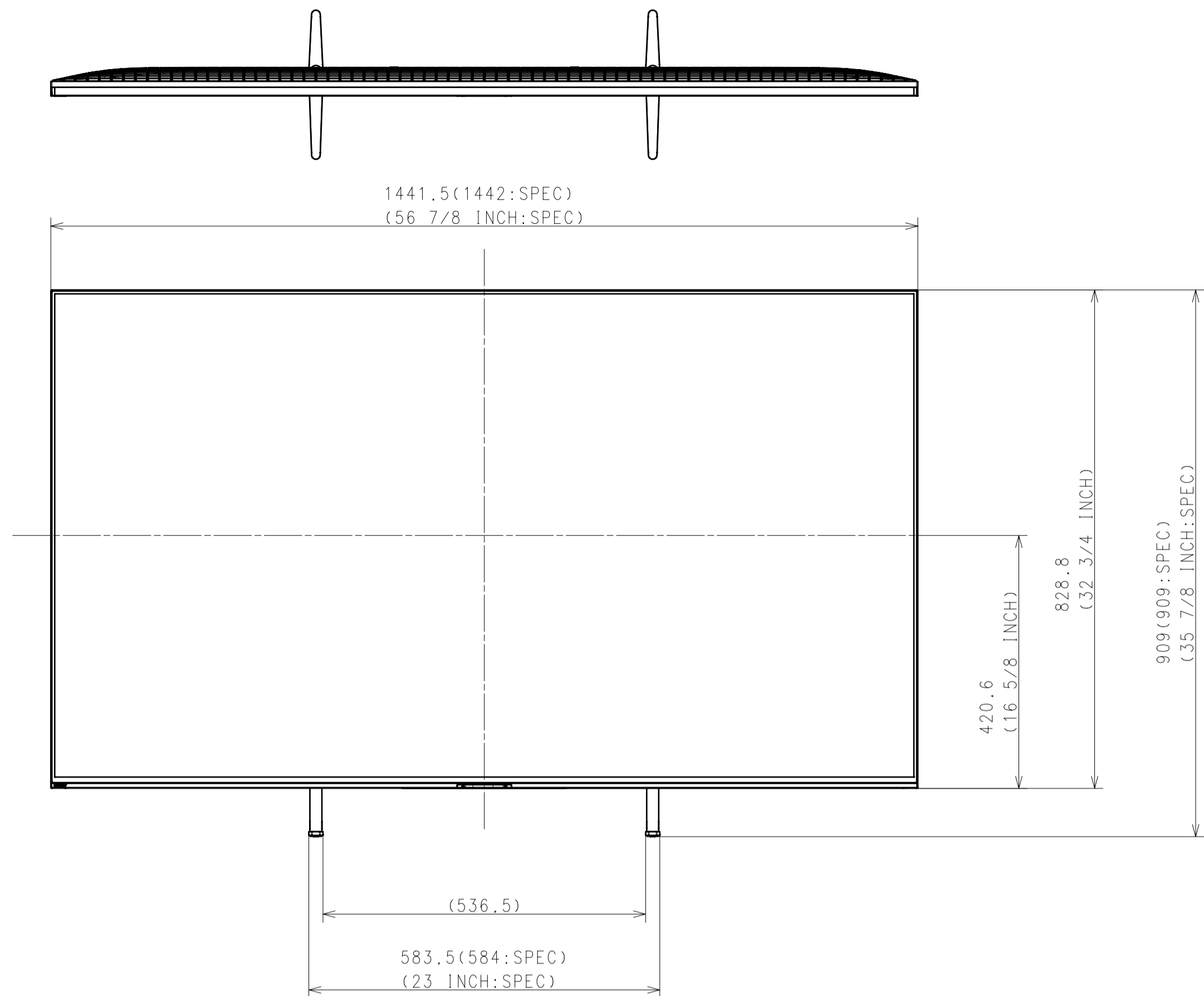
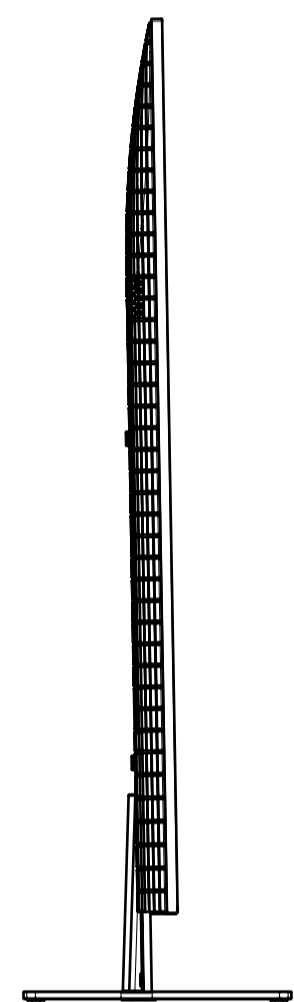

50.8  
(2 INCH)

105.3  
(4 1/4 INCH)  
248 (248:SPEC)  
(9 7/8 INCH:SPEC)  
(8.5)

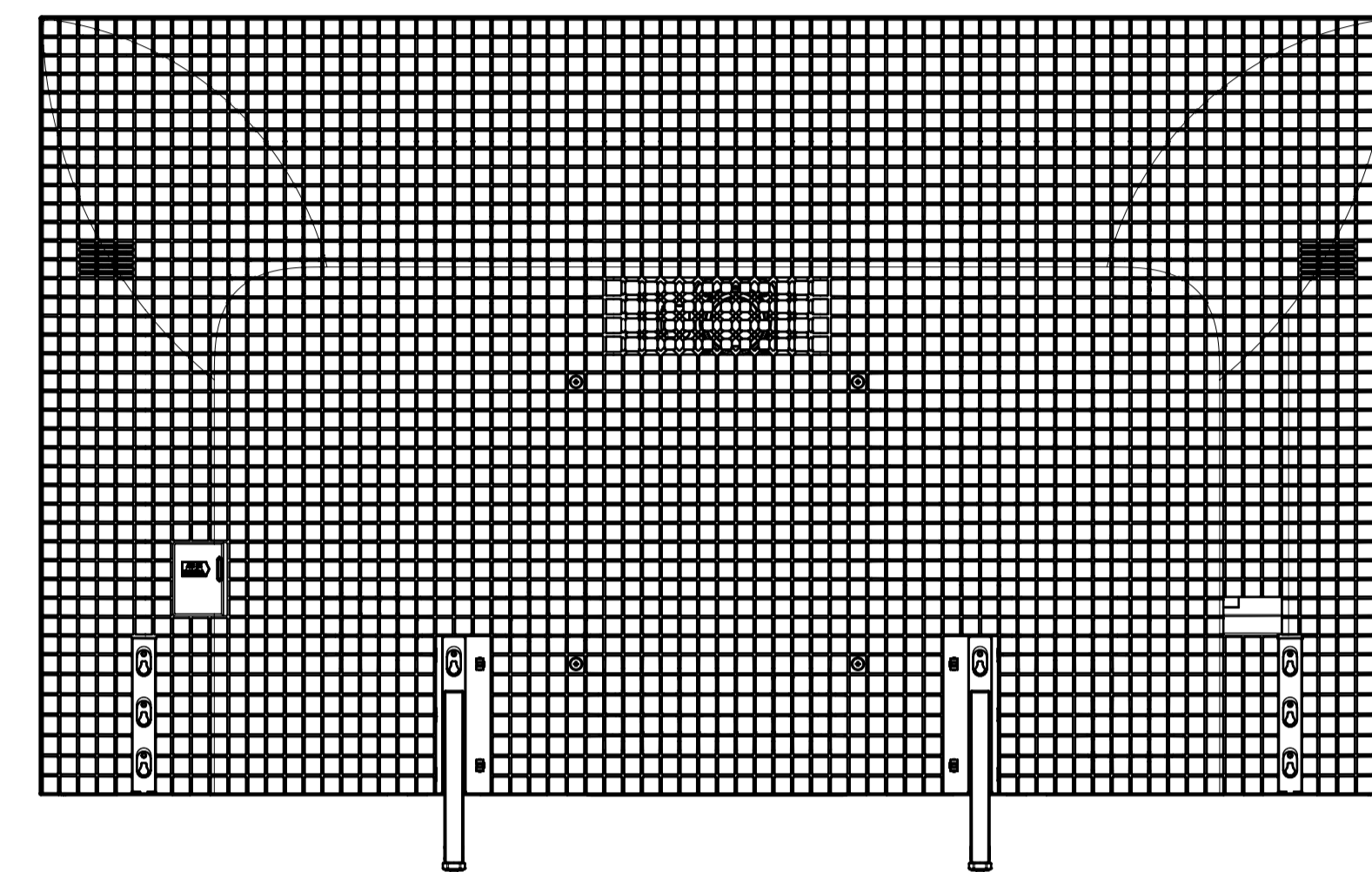

DESCRIPTION 1	LEGAL OWNER	SCALE
65 (XR80) EXTERIOR VIEW	Sony Corporation	1:7
DESCRIPTION 2	PART NO.	SHEET/PAGES
65 (XR80) EXTERIOR VIEW		3 / 8

WITHOUT STAND

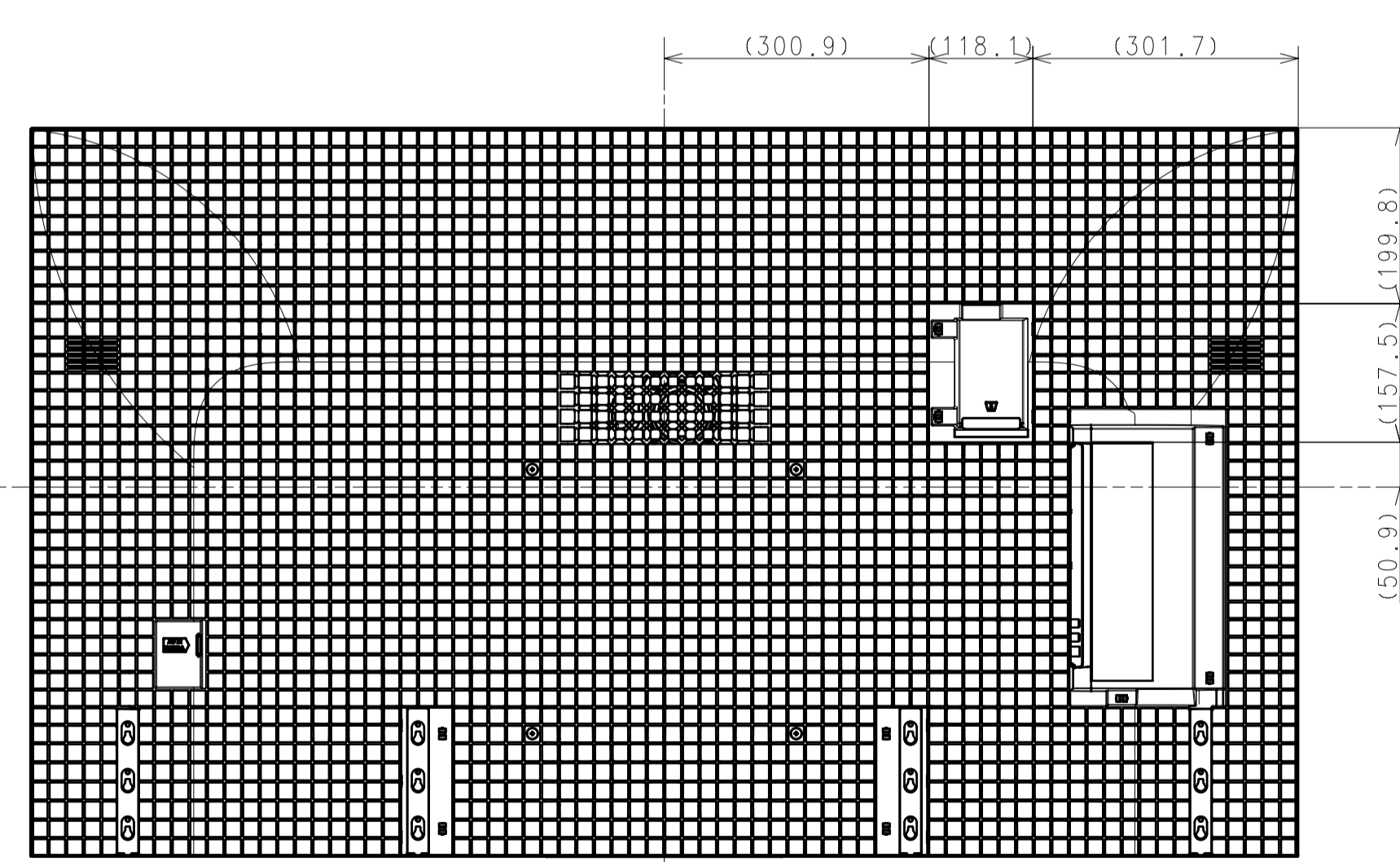
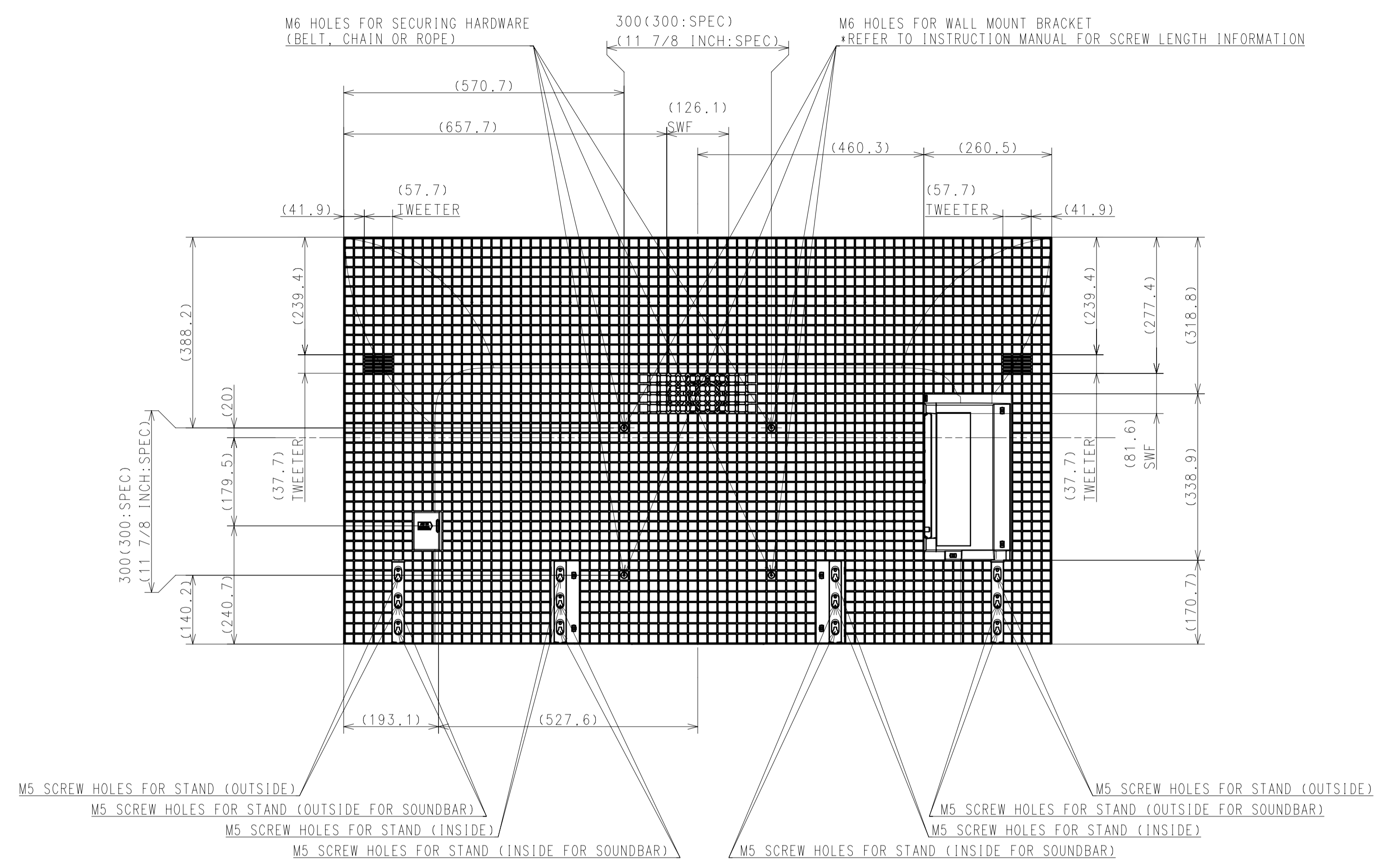
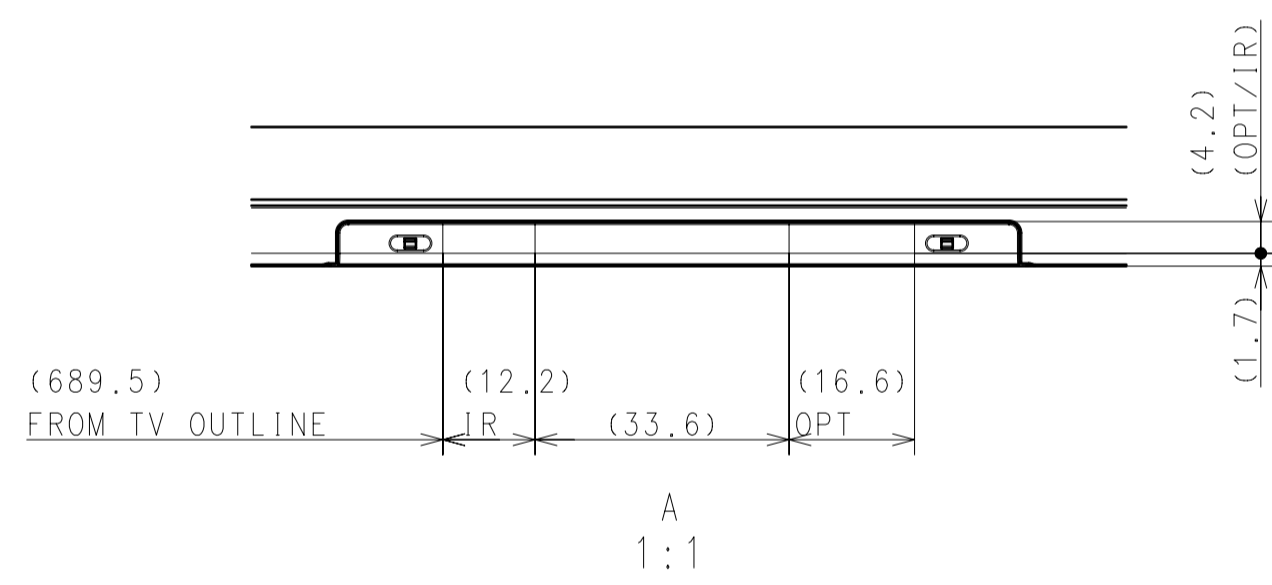
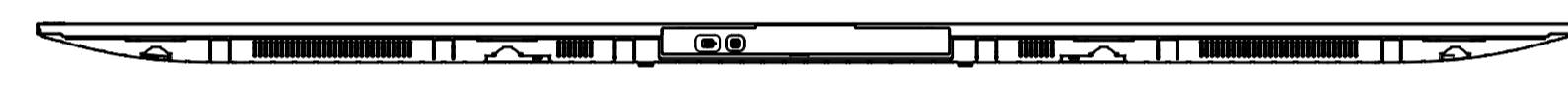
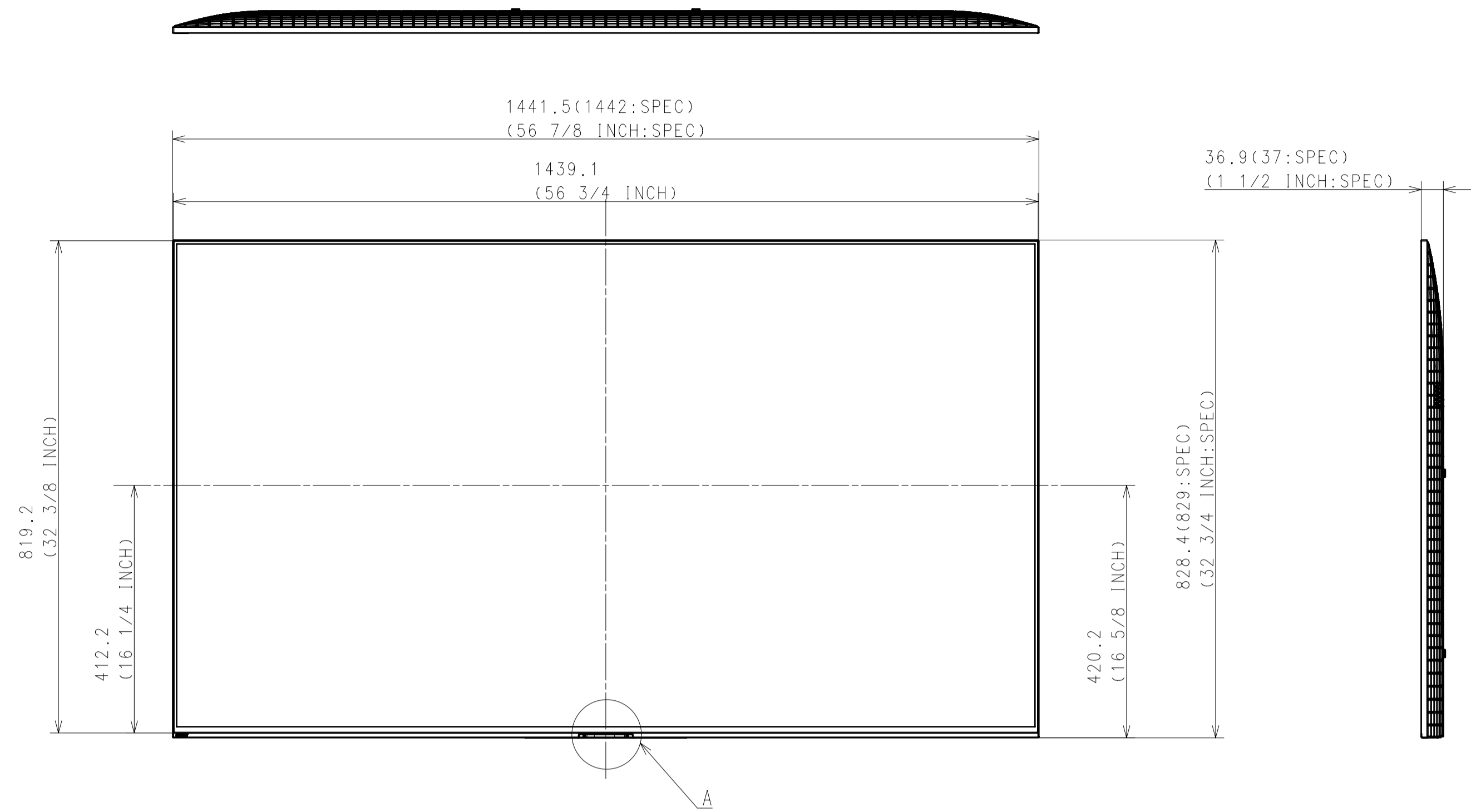

FOR EUROPE

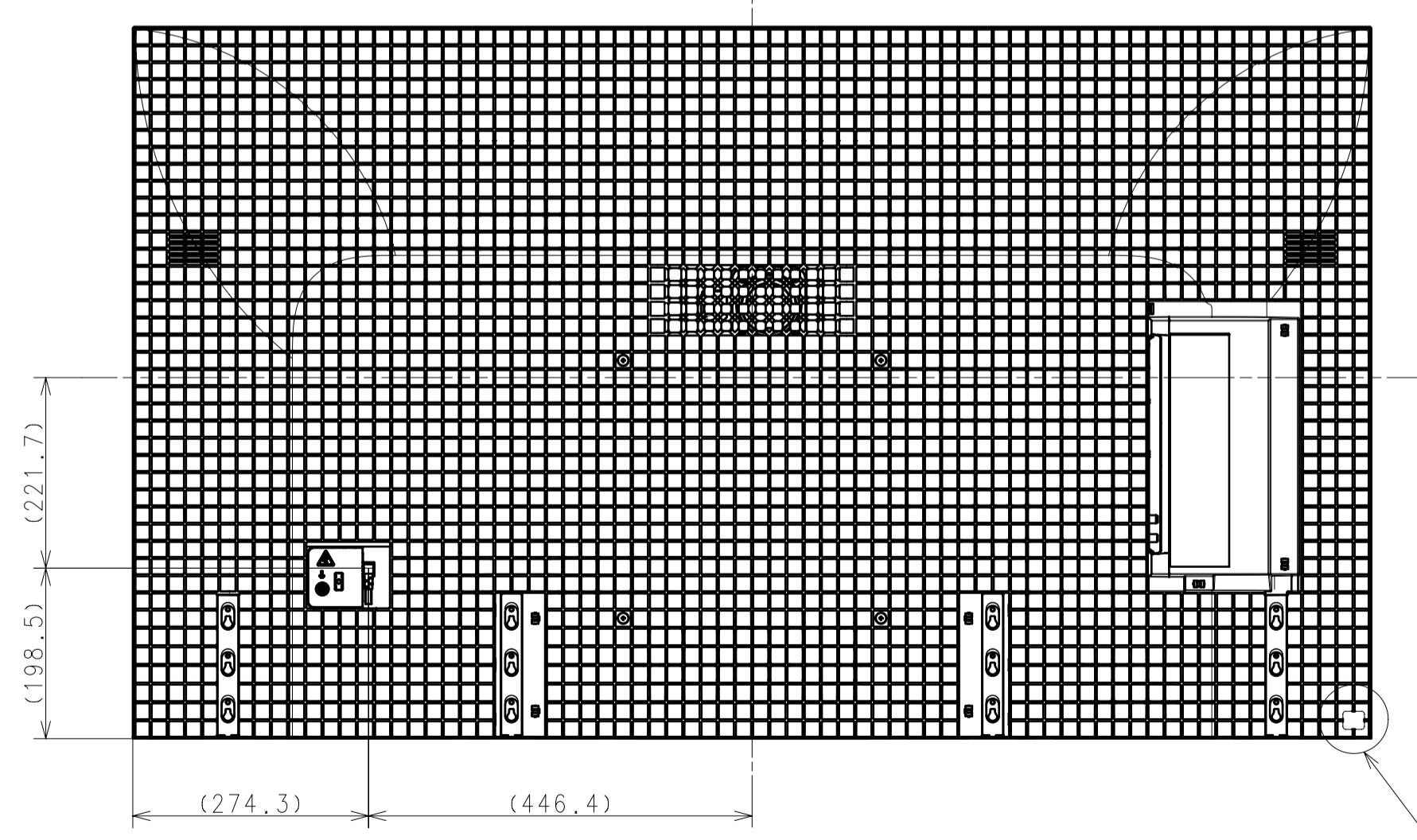

FOR JAPAN / LATIN AMERICA / INDIA

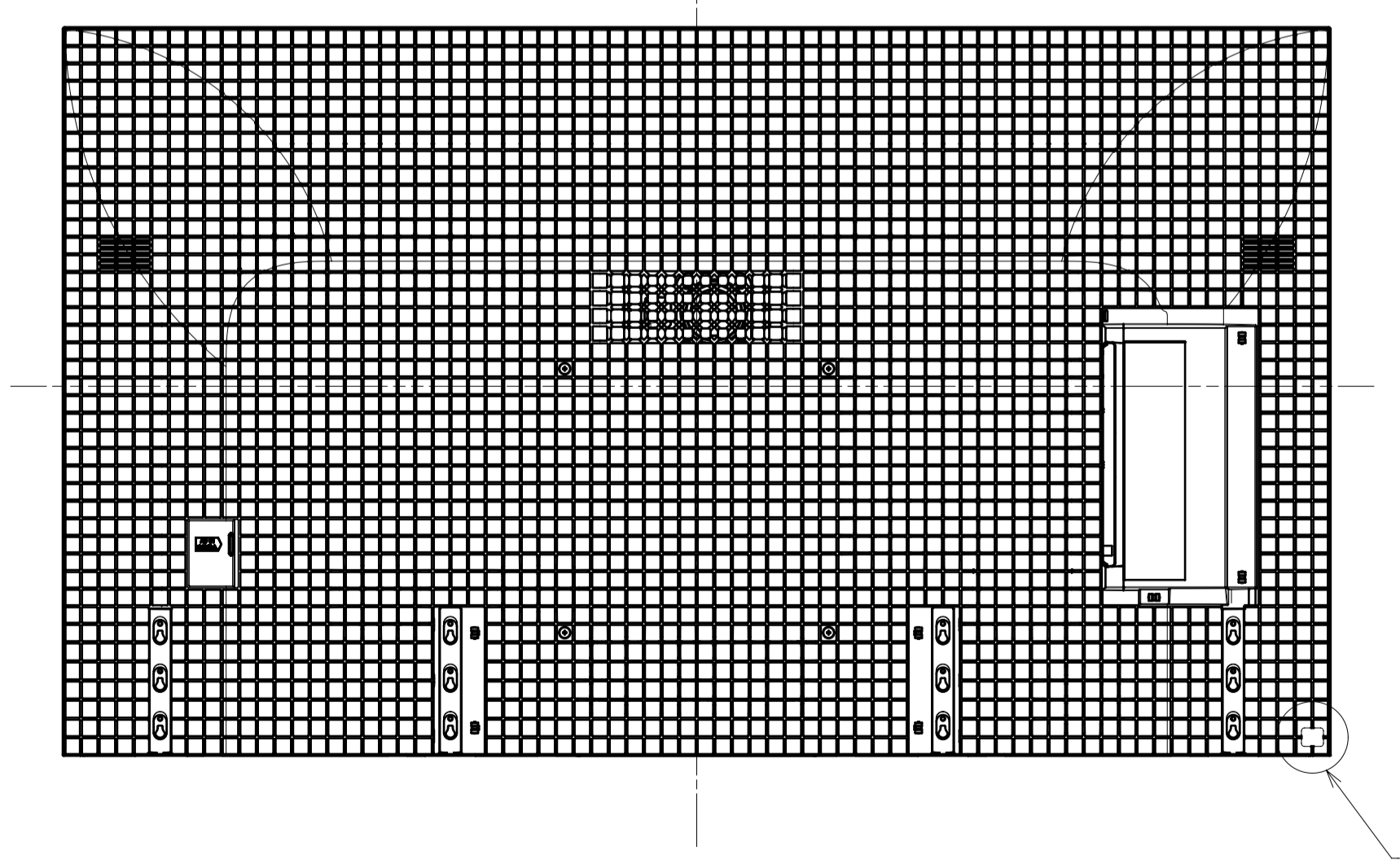

FOR GENERAL AREA / NORTH AMERICA / CHINA

DESCRIPTION 1 65 (XR80) EXTERIOR VIEW	LEGAL OWNER Sony Corporation	SCALE 1:7
DESCRIPTION 2 65 (XR80) EXTERIOR VIEW	PART NO.	SHEET/PAGES 4 / 8

SU-WL450

STANDARD

SLIM

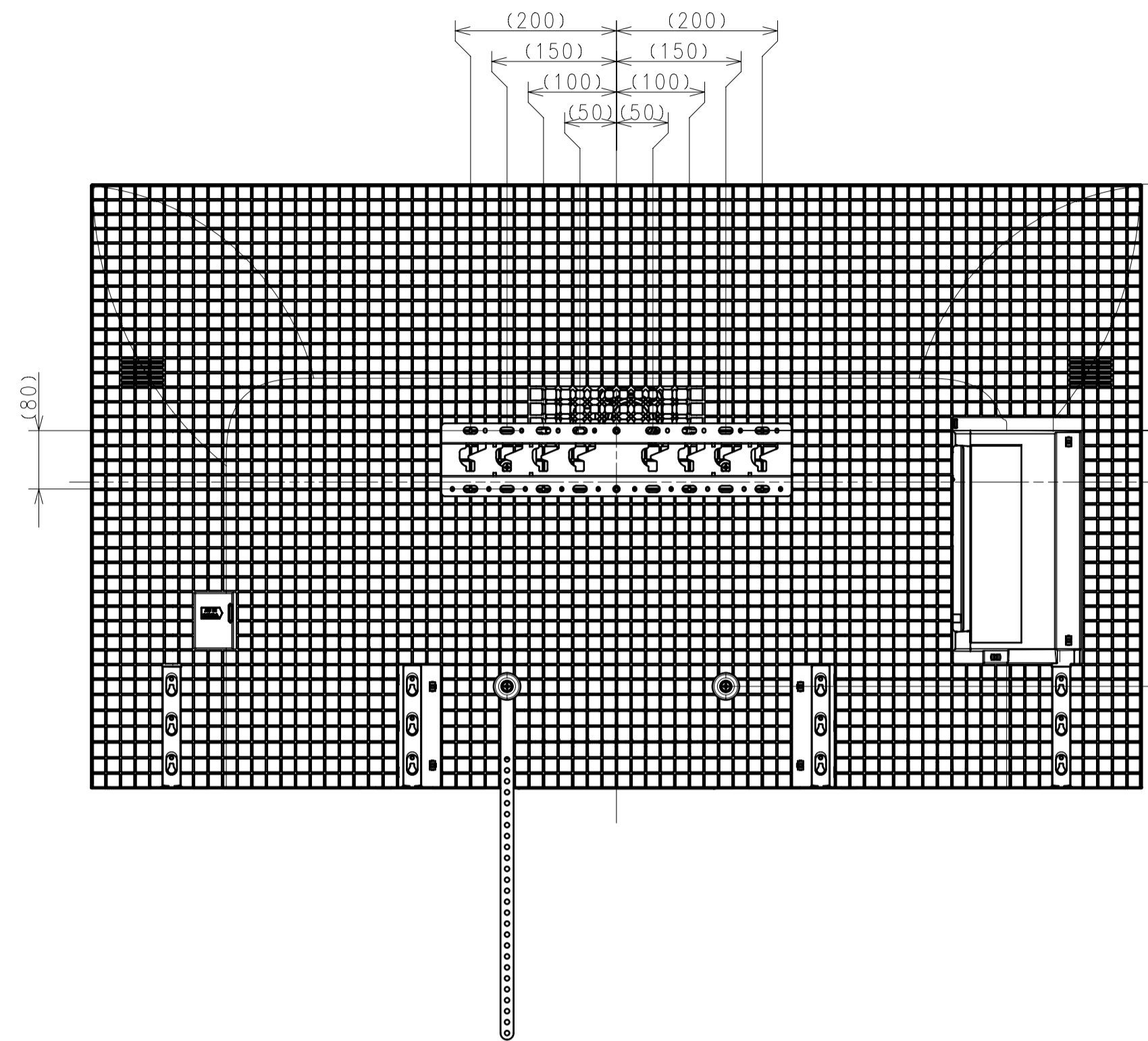

70.5 (71:SPEC)  
(2.7/8 INCH:SPEC)

350.5 (351:SPEC)  
(13.7/8 INCH:SPEC)

99 (99:SPEC)  
(4 INCH:SPEC)

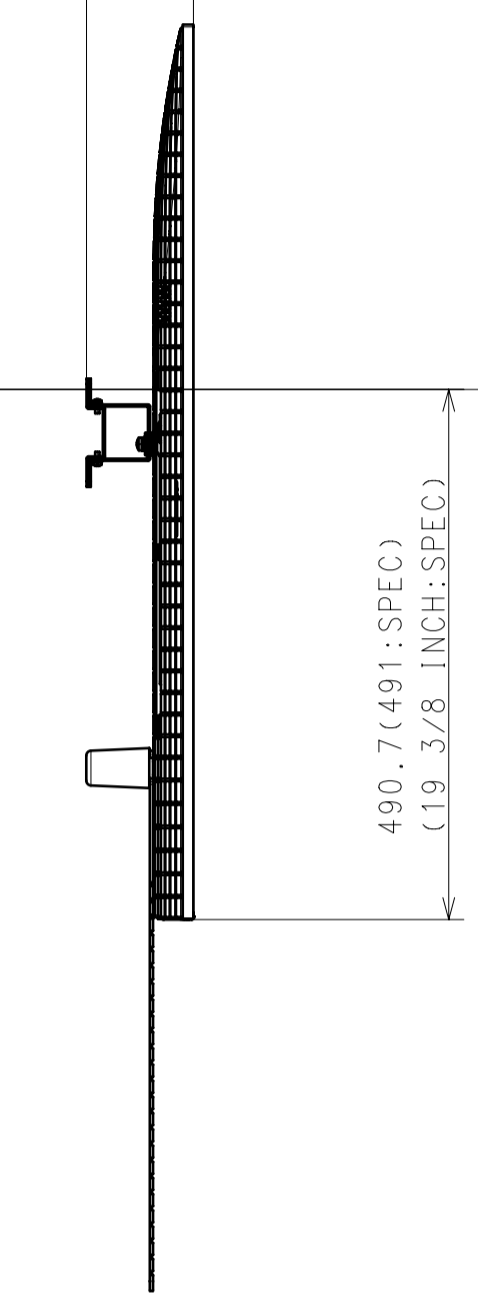

490.7 (491:SPEC)  
(19.3/8 INCH:SPEC)

57.2 (58:SPEC)  
(2.3/8 INCH:SPEC)

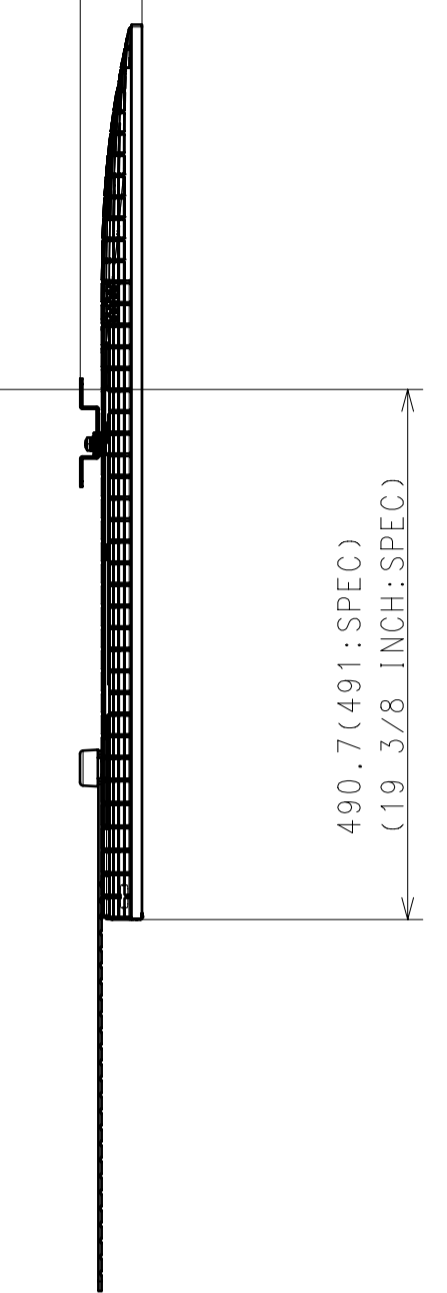

490.7 (491:SPEC)  
(19.3/8 INCH:SPEC)

DRAWING

SONY STANDARD

DESCRIPTION 1	LEGAL OWNER	SCALE
65 (XR80) EXTERIOR VIEW	Sony Corporation	1:7
DESCRIPTION 2	PART NO.	SHEET/PAGES
65 (XR80) EXTERIOR VIEW		5/8

SU-WL850

SU-WL855 WITH LATERAL SHAFT BRACKET

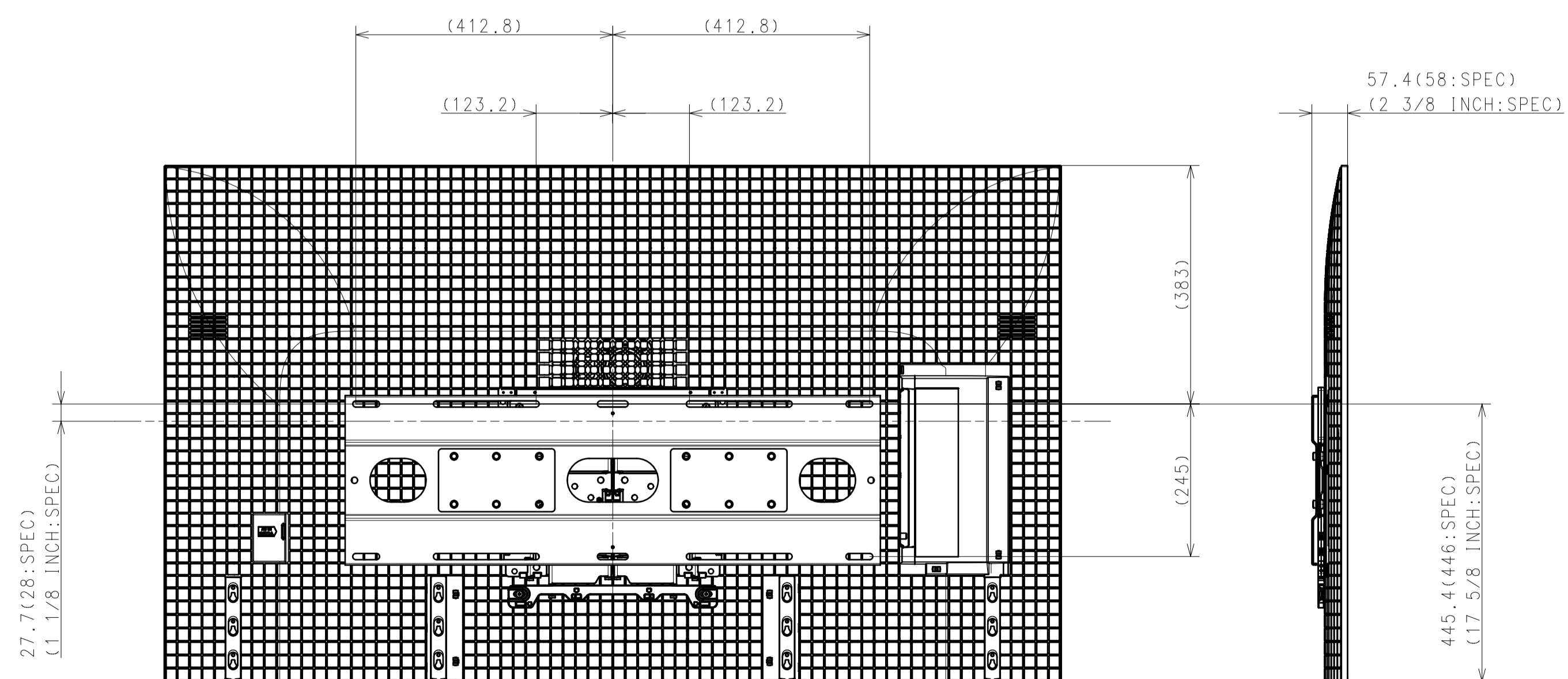
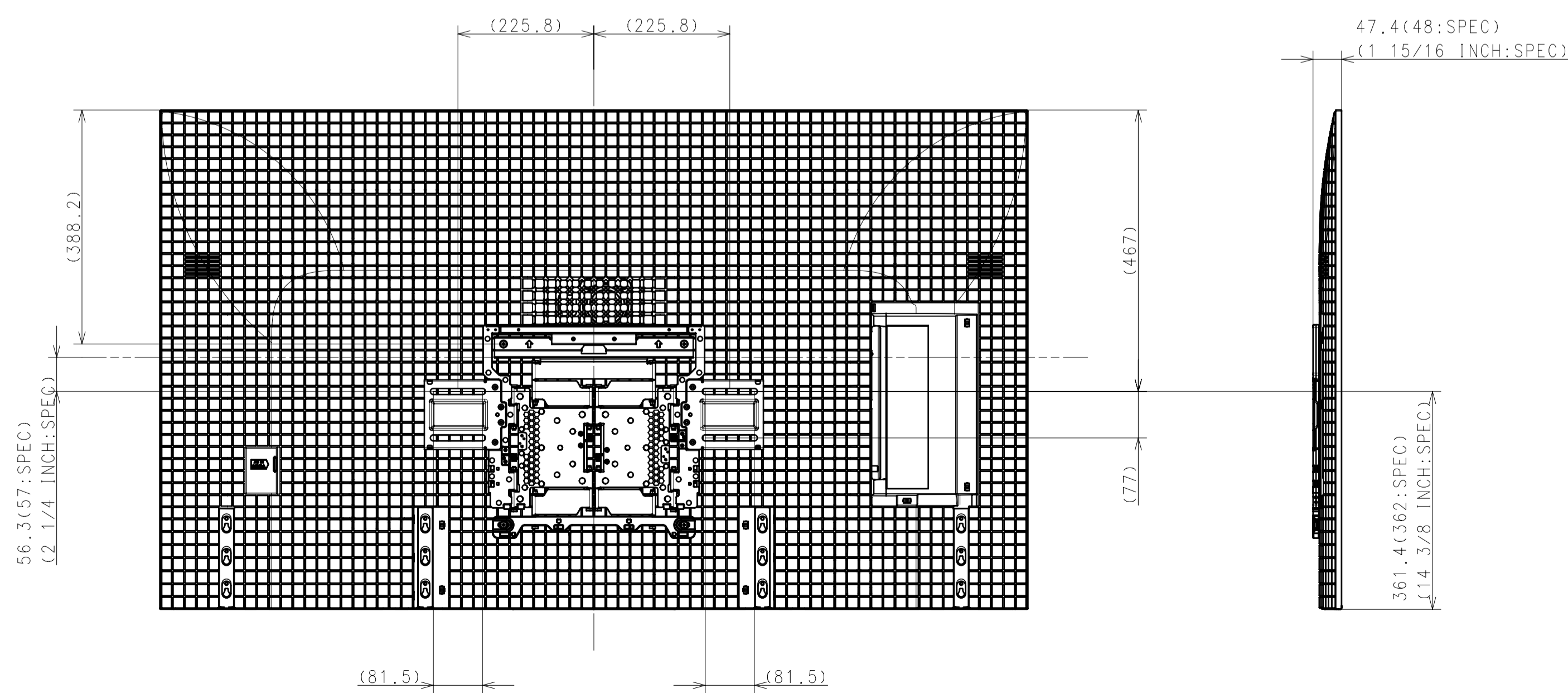
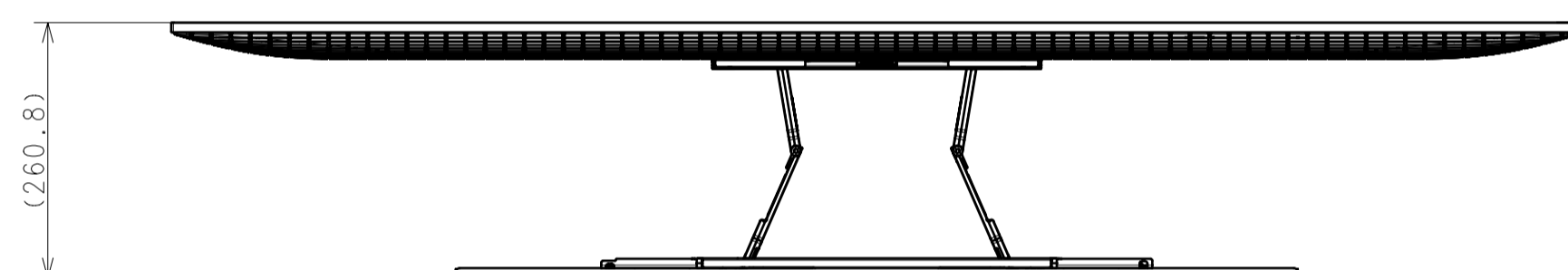
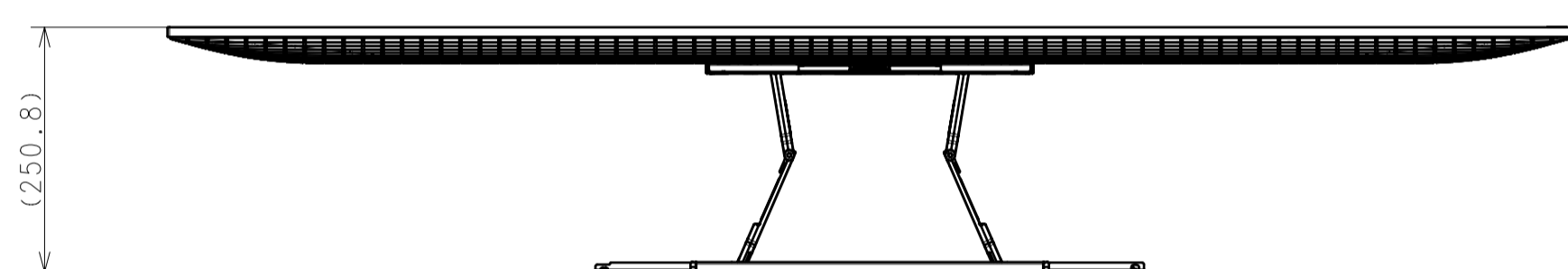
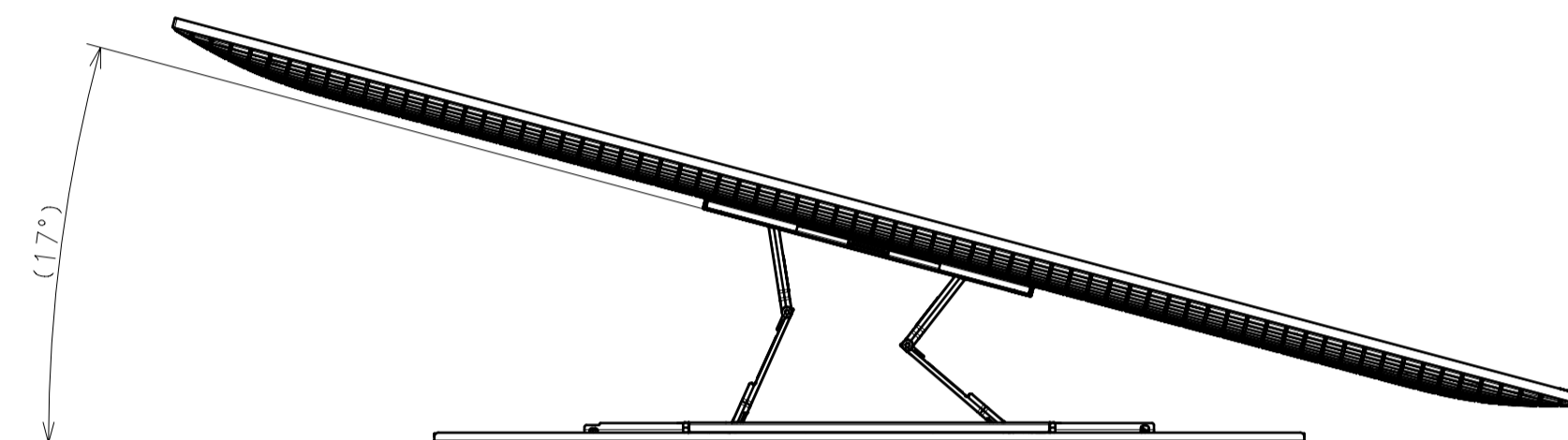
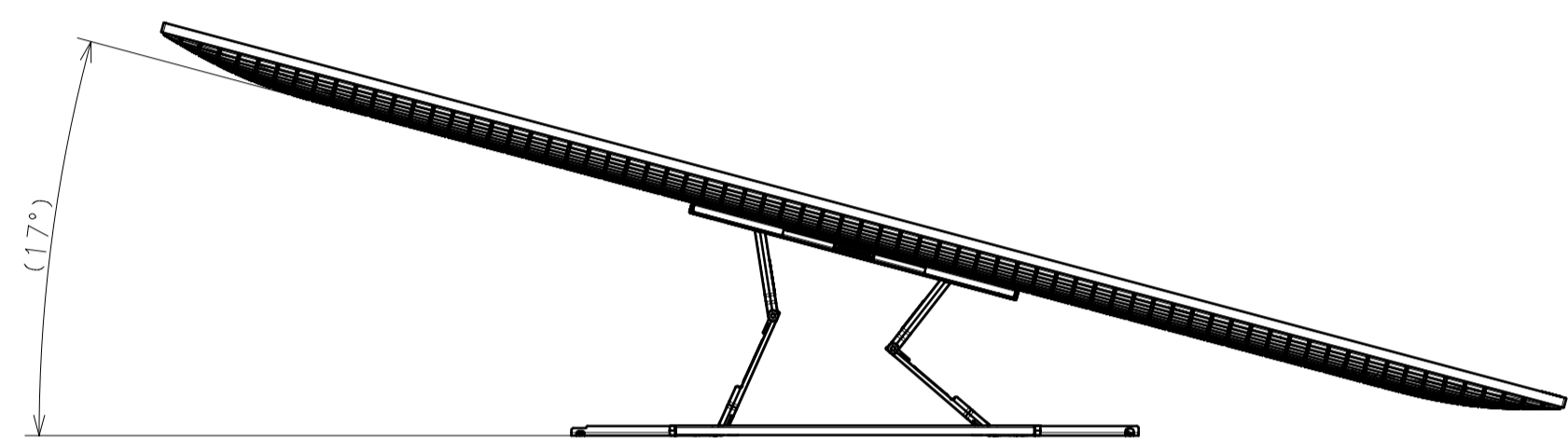
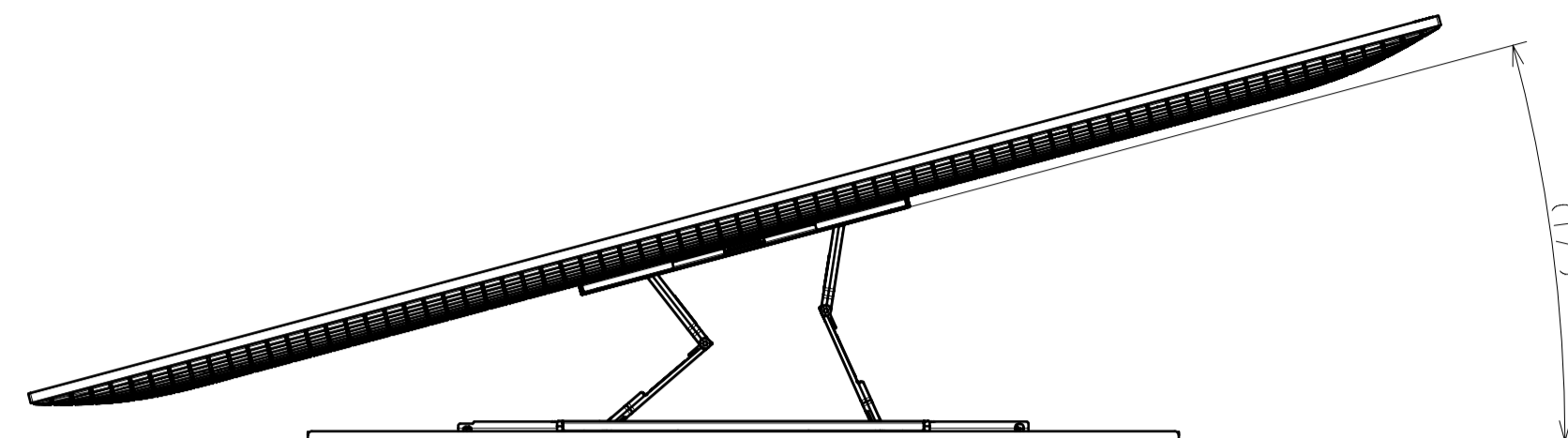
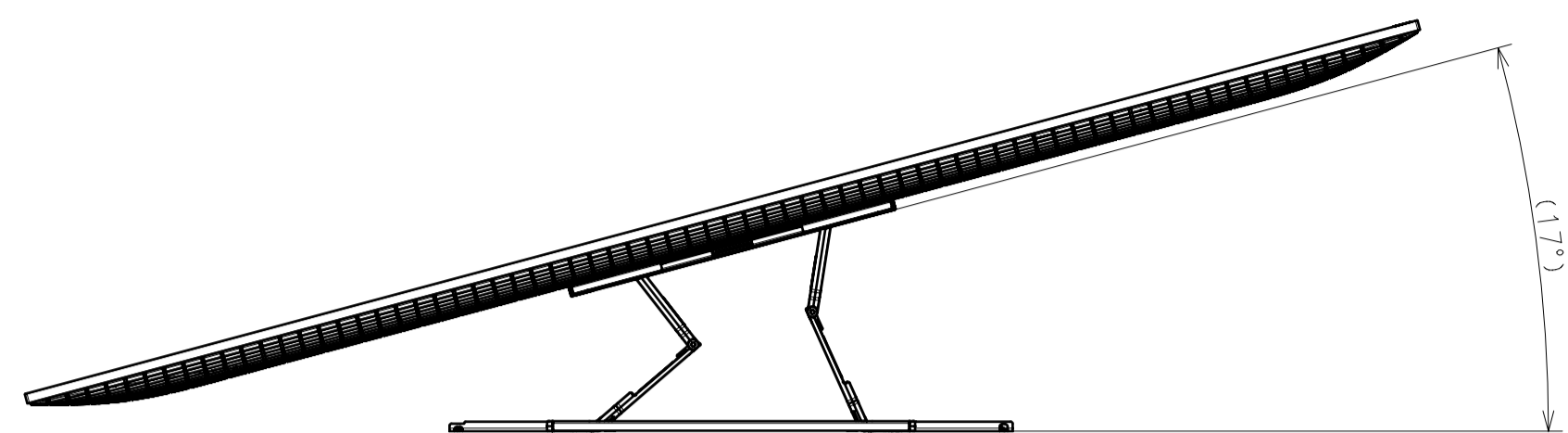

DESCRIPTION 1	65 (XR80) EXTERIOR VIEW	LEGAL OWNER	Sony Corporation	SCALE	1:7
DESCRIPTION 2	65 (XR80) EXTERIOR VIEW	PART NO.		SHEET/PAGES	6 / 8

SU-WL900 (STANDARD)

SU-WL905 (STANDARD) WITH LATERAL SHAFT BRACKET

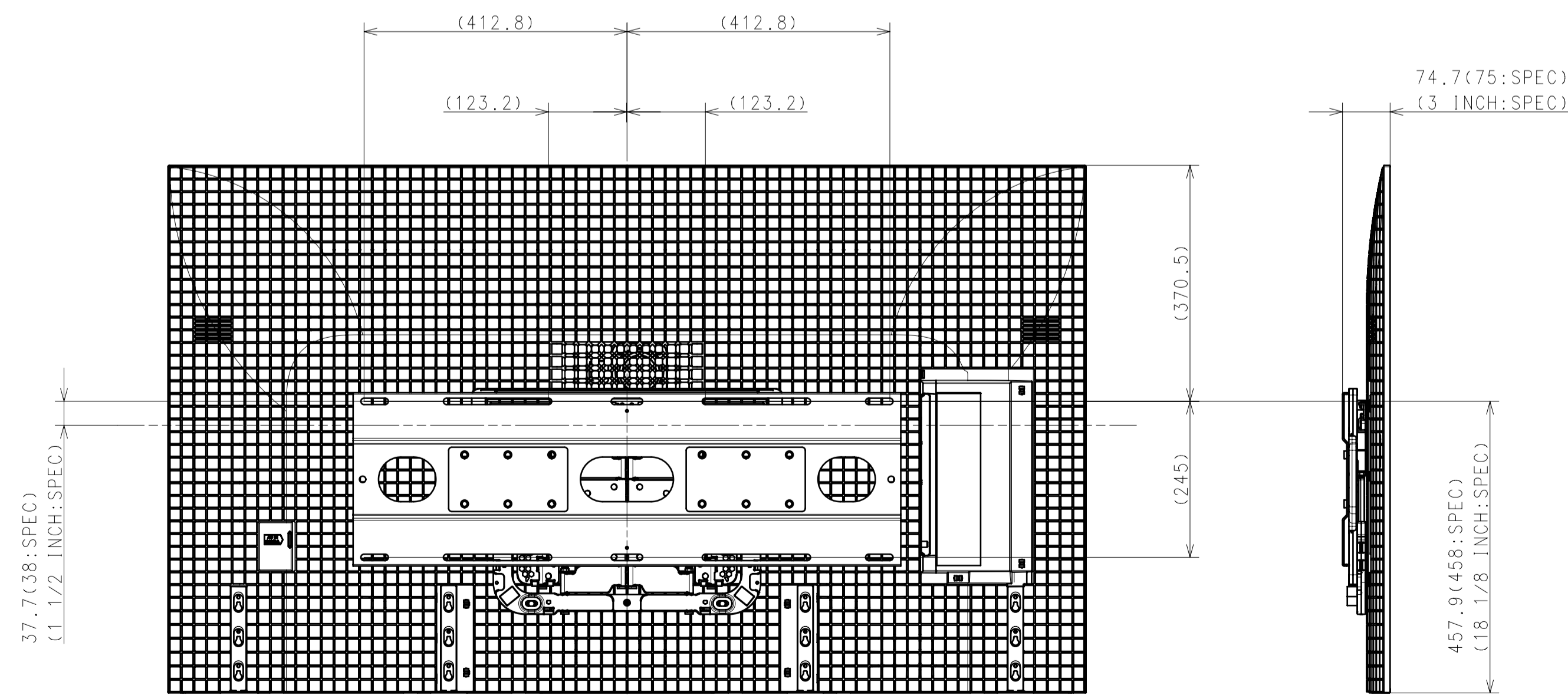
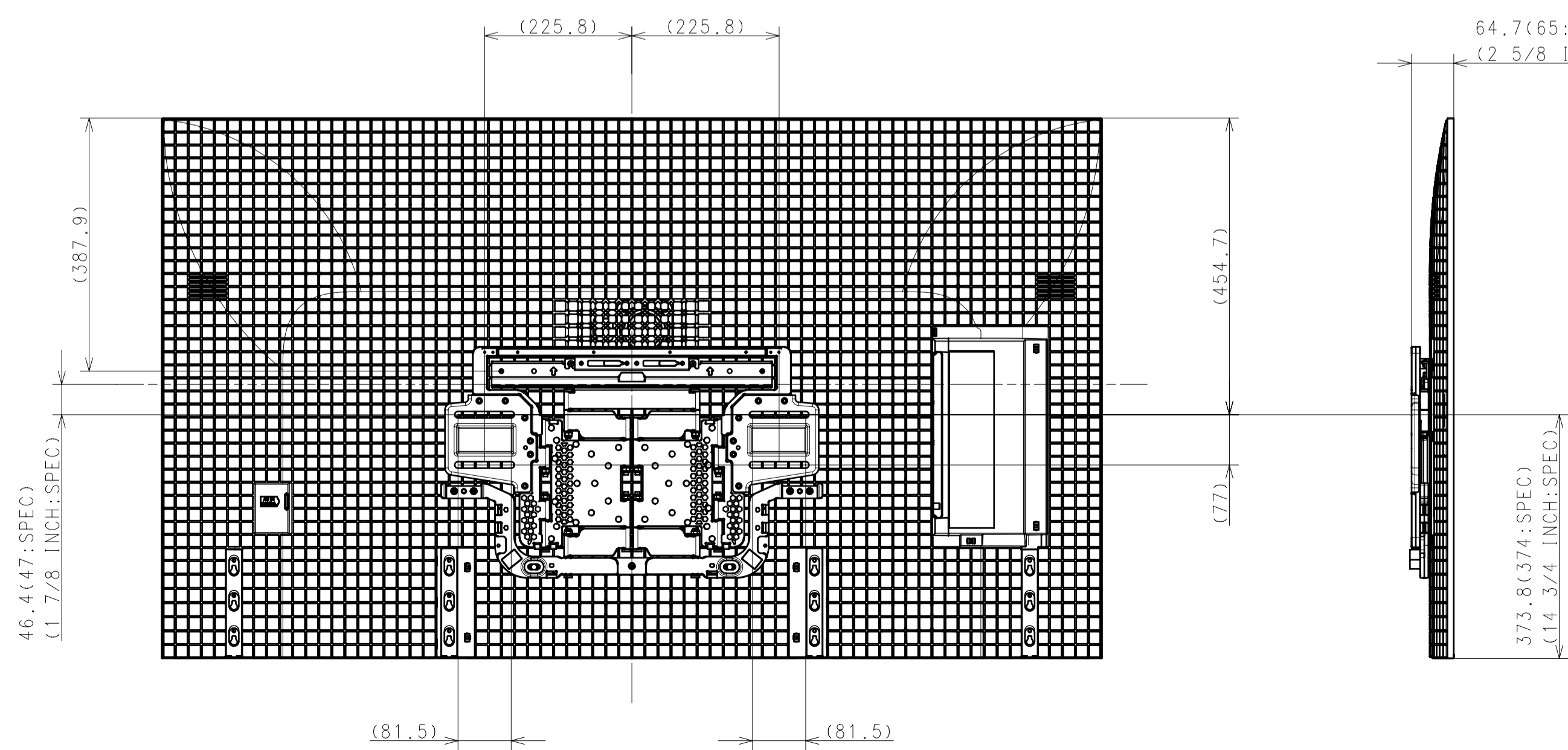
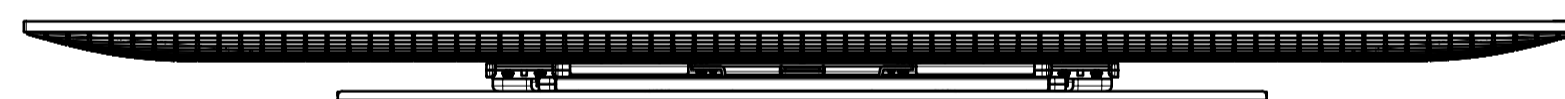
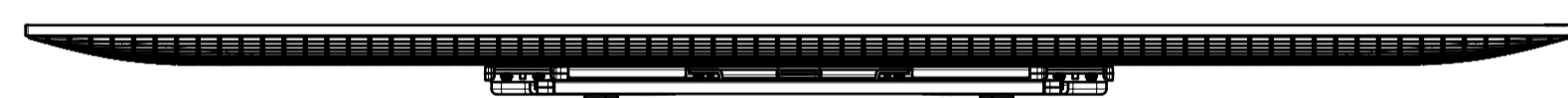
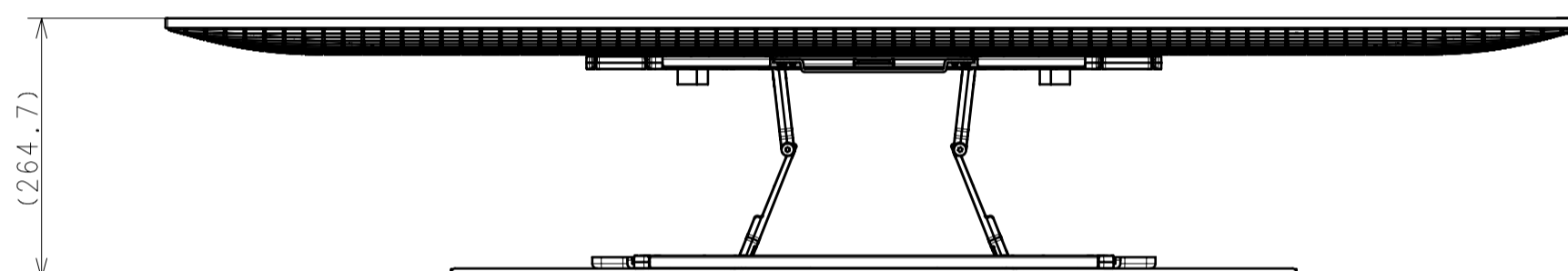
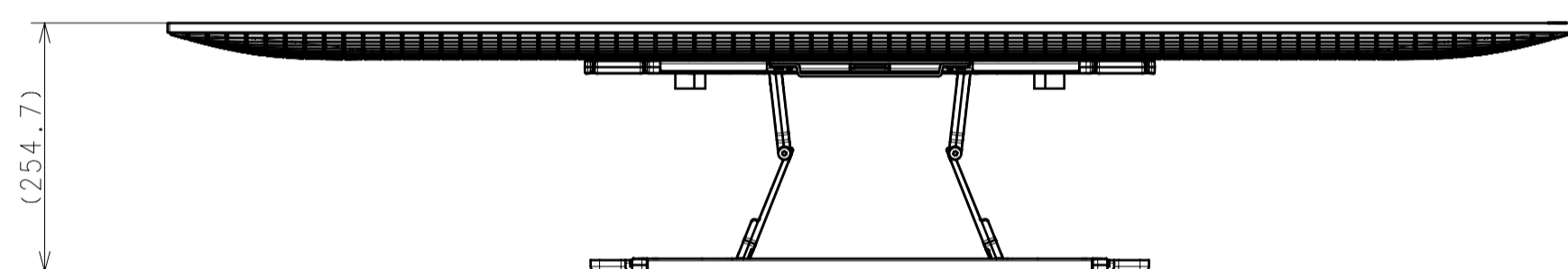
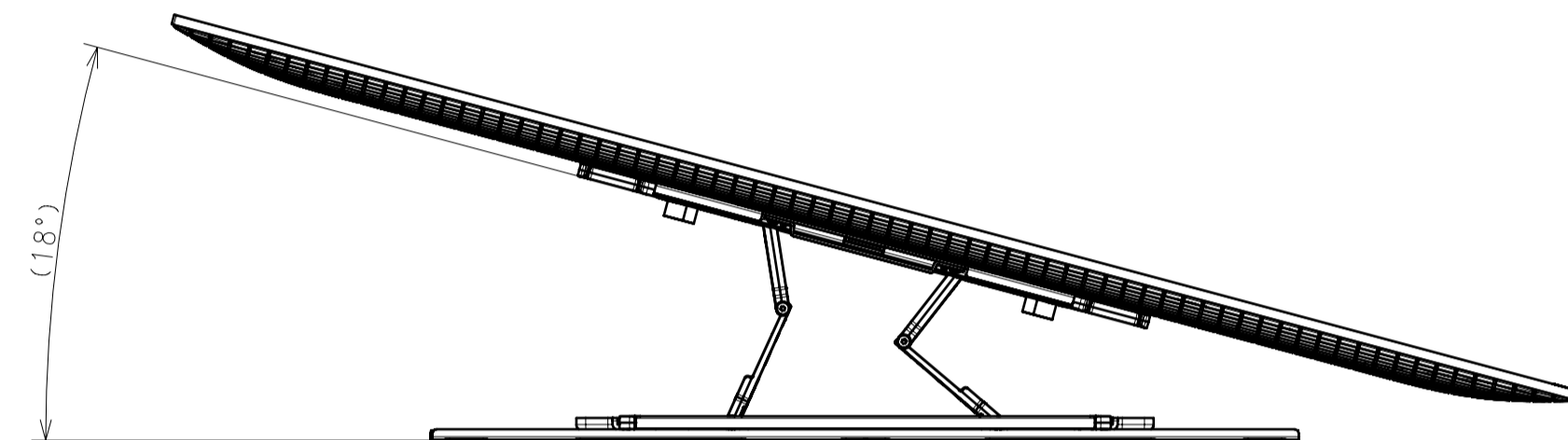
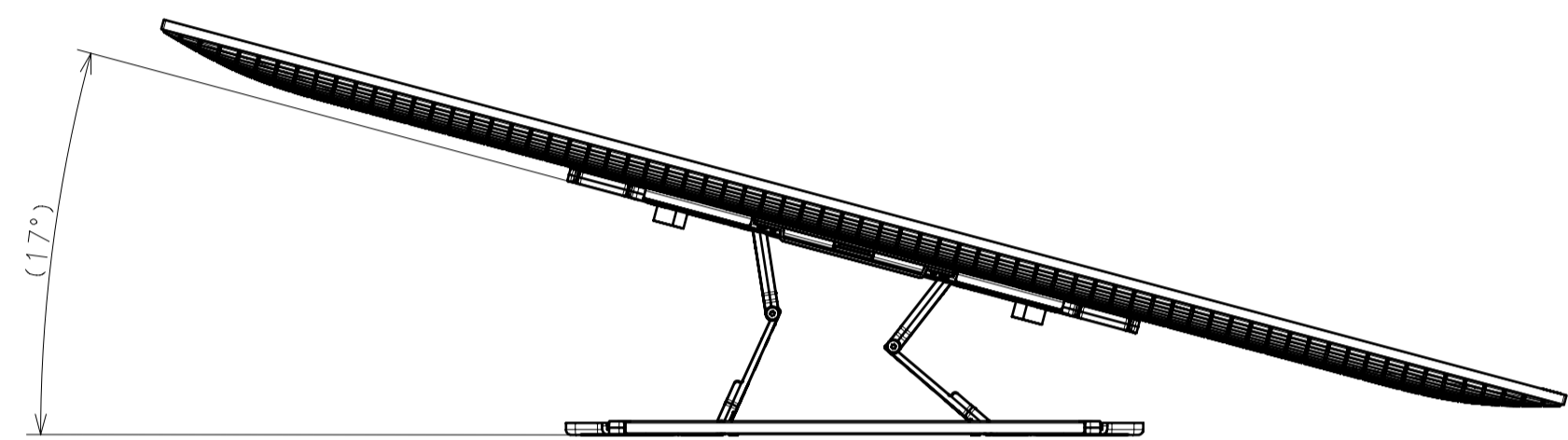
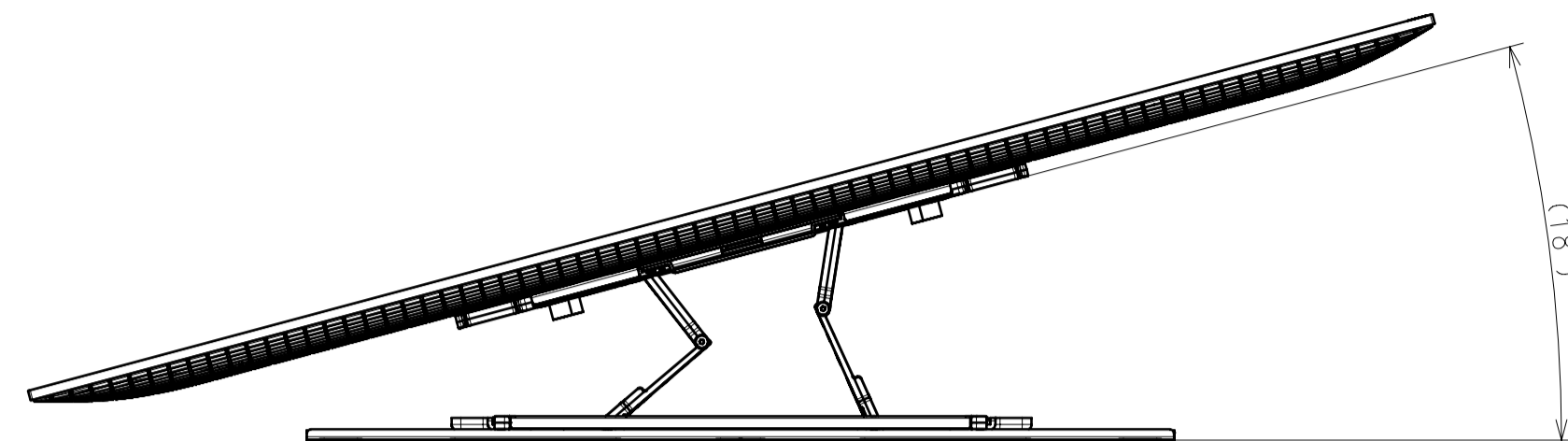
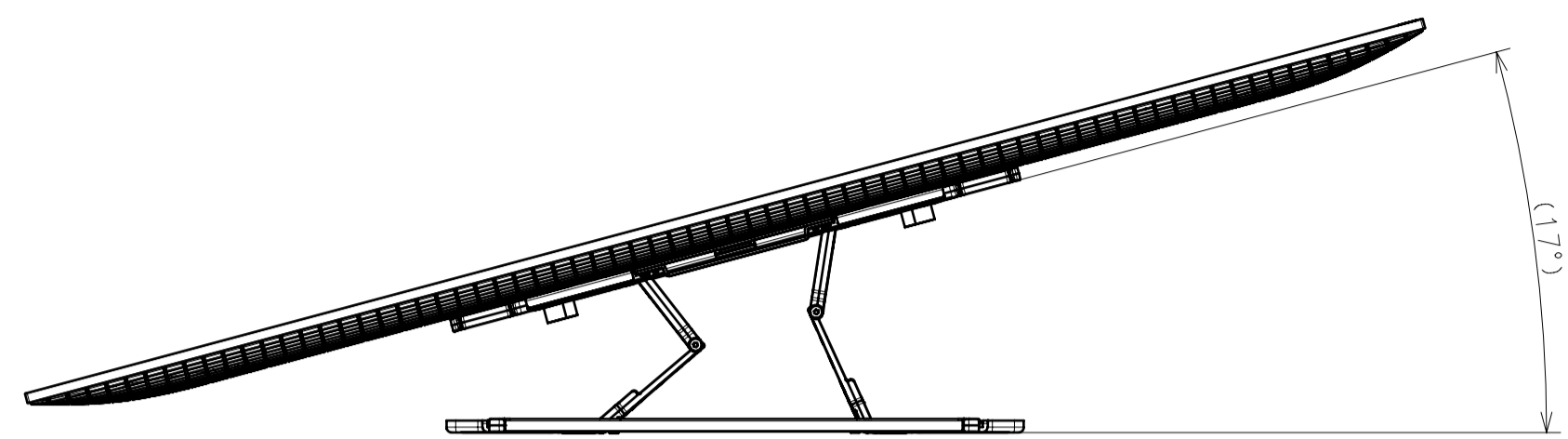

DESCRIPTION 1	65 (XR80) EXTERIOR VIEW	LEGAL OWNER	Sony Corporation	SCALE	1:7
DESCRIPTION 2	65 (XR80) EXTERIOR VIEW	PART NO.		SHEET/PAGES	7 / 8

SU-WL900 (SLIM)

SU-WL905 (SLIM) WITH LATERAL SHAFT BRACKET

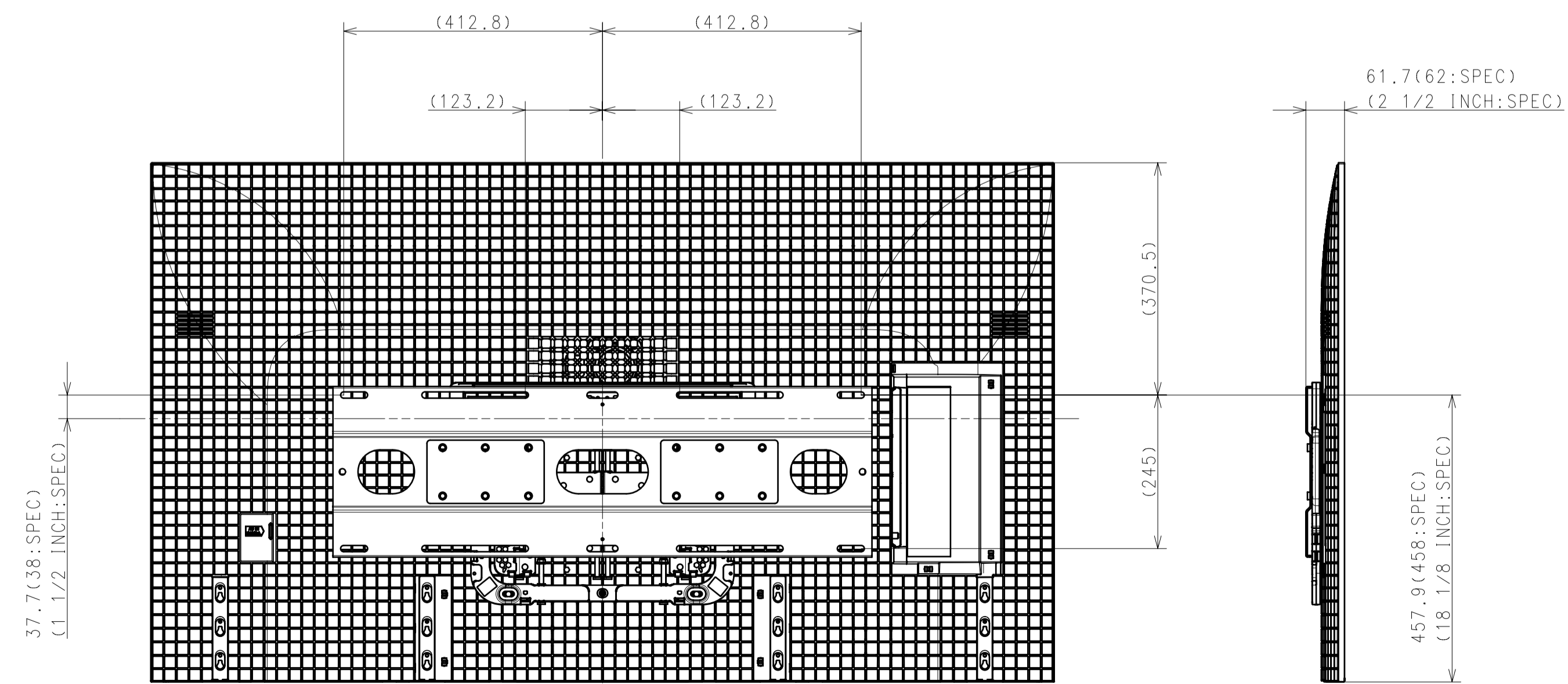
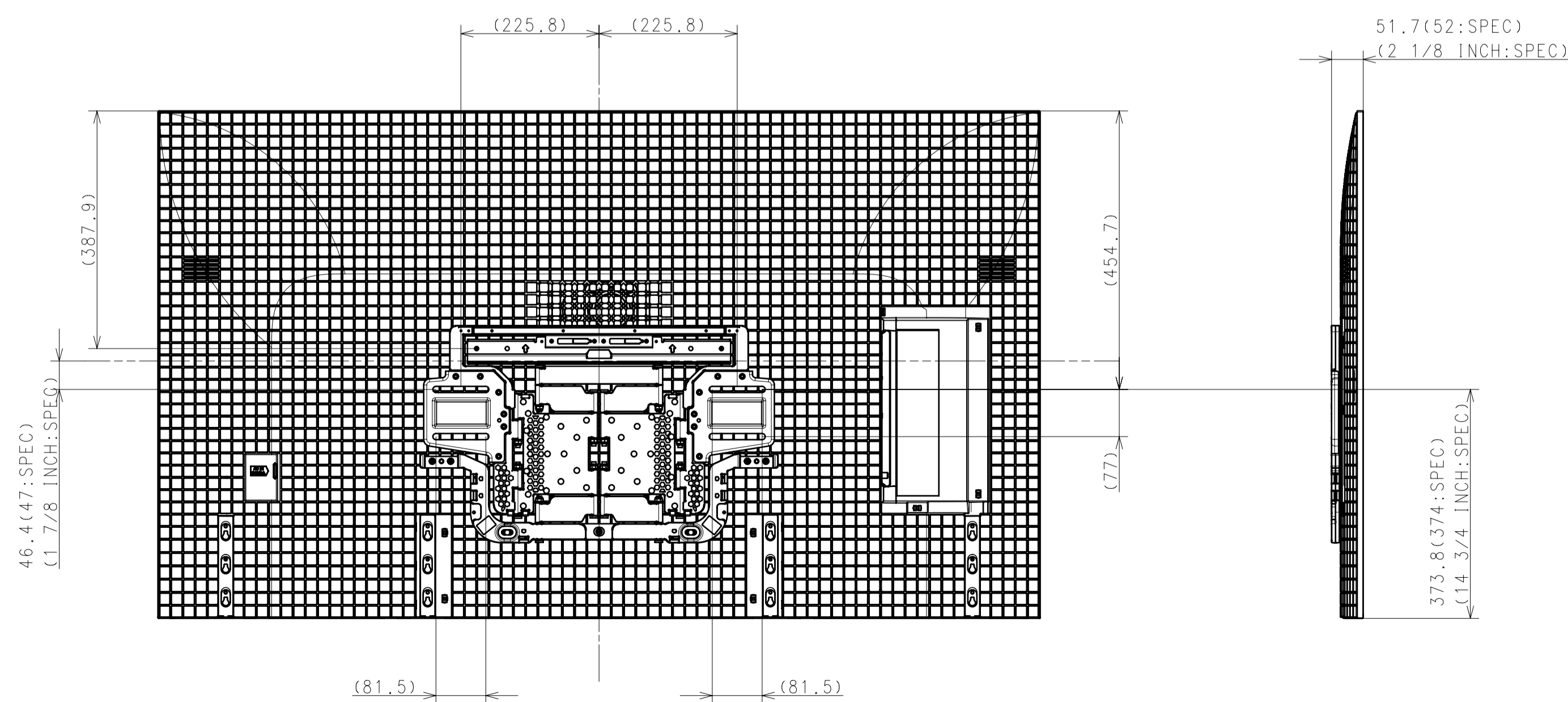
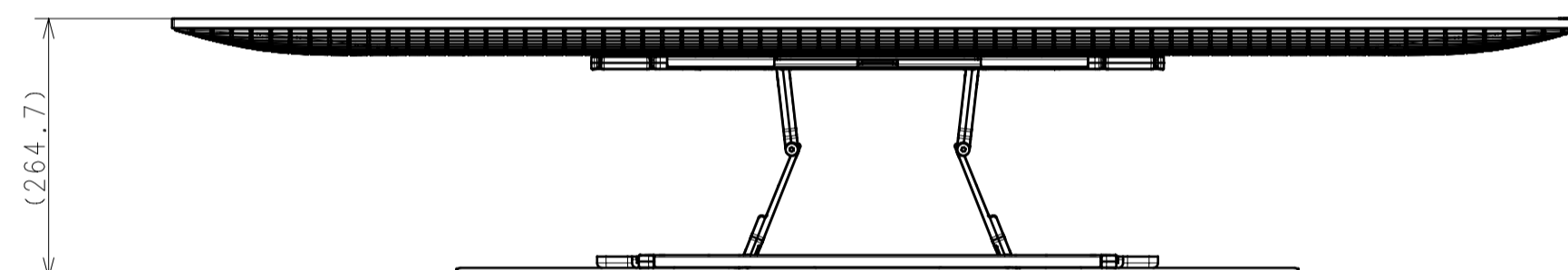
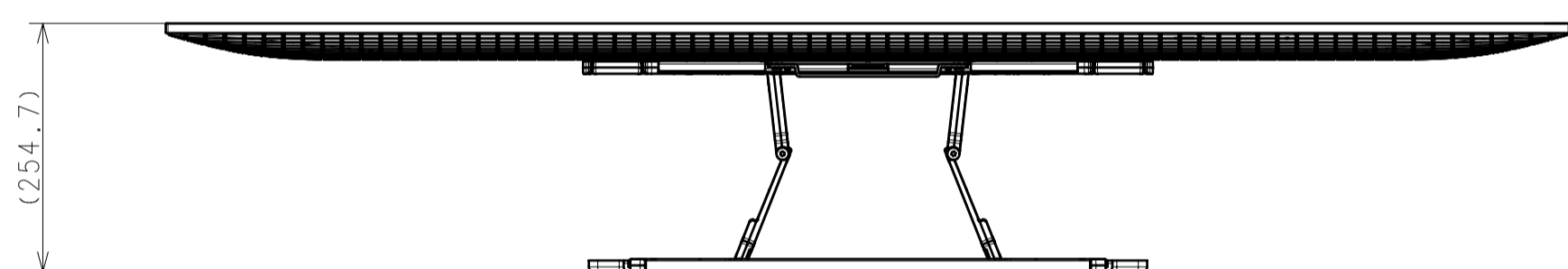
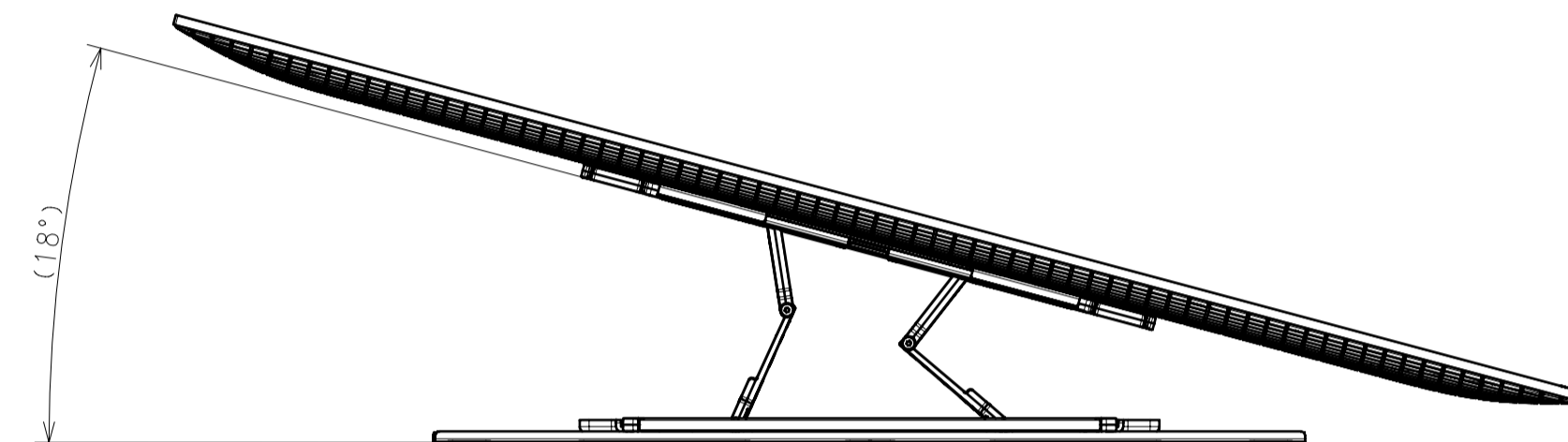
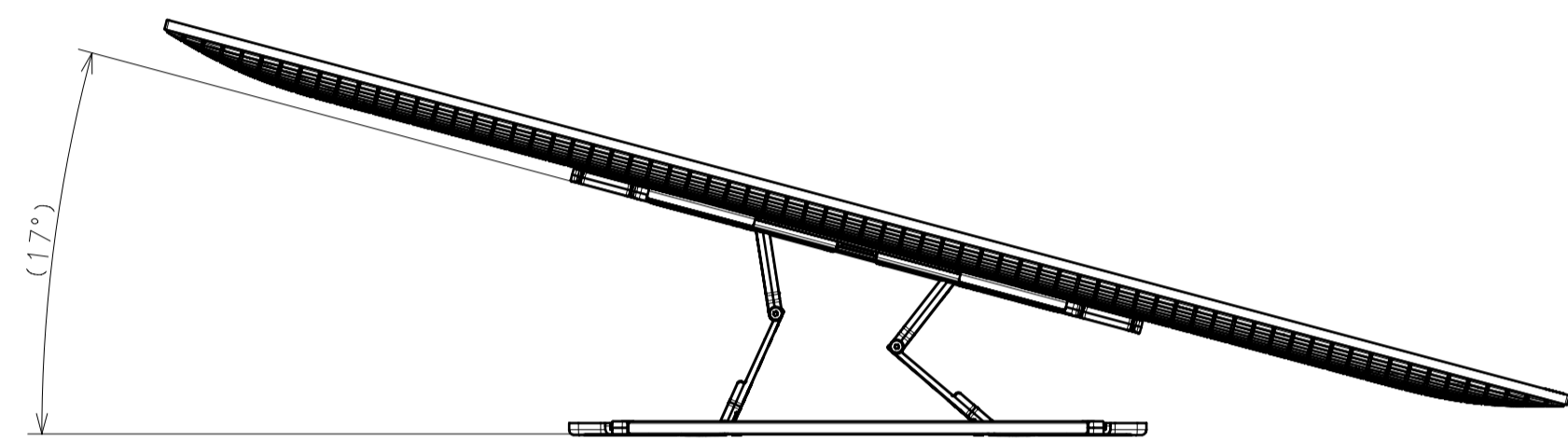
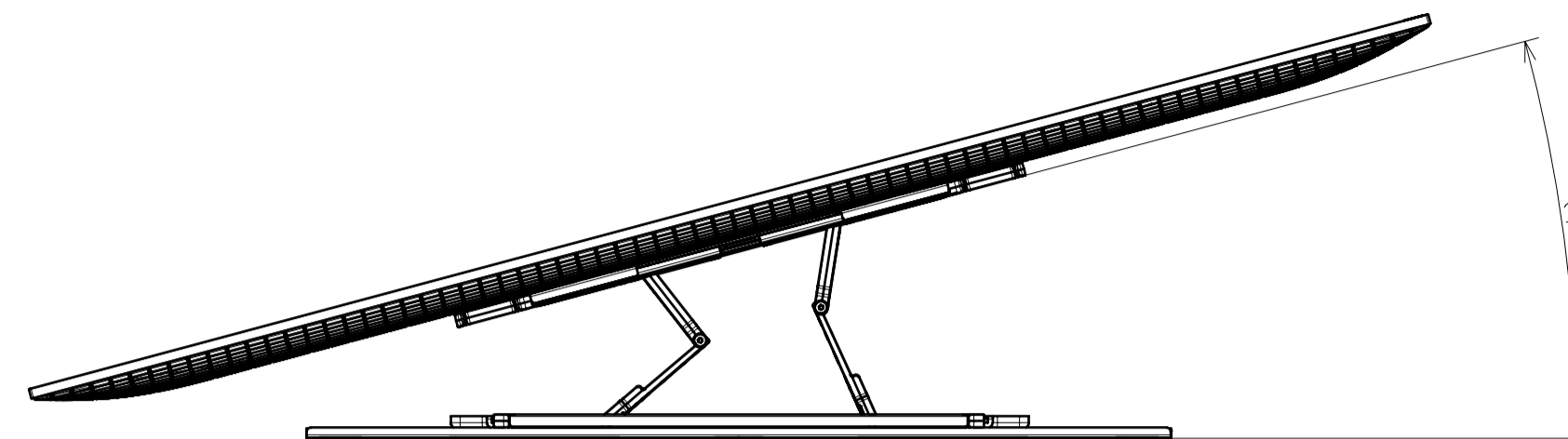
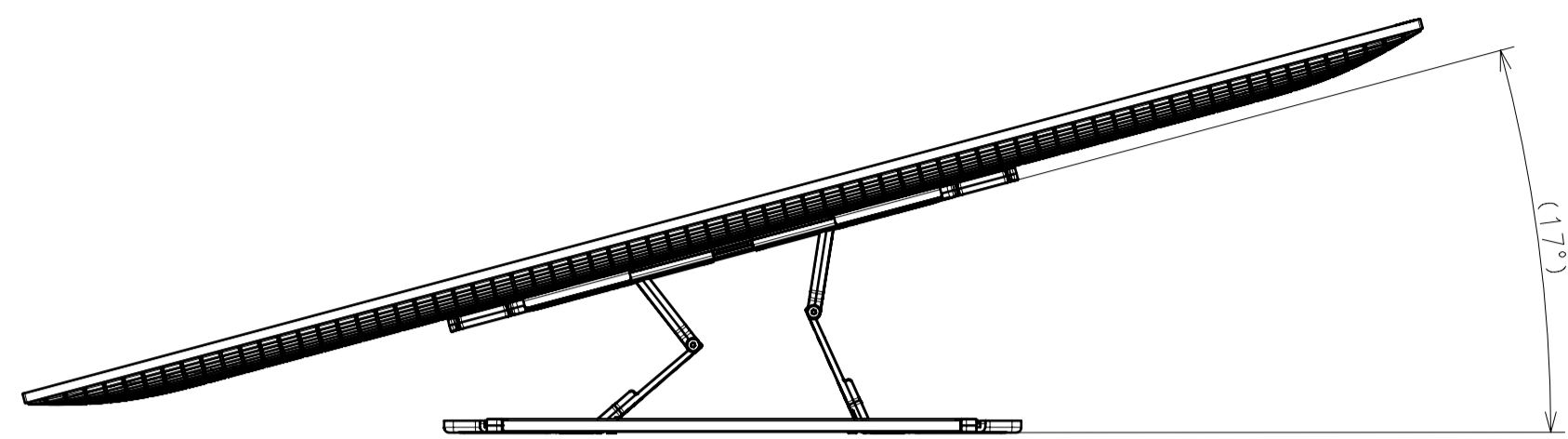

DESCRIPTION 1	65 (XR80) EXTERIOR VIEW	LEGAL OWNER	Sony Corporation	SCALE	1:7
DESCRIPTION 2	65 (XR80) EXTERIOR VIEW	PART NO.		SHEET/PAGES	8 / 8