

WITH STAND

Area		NORTH AMERICA	LATIN AMERICA	GENERAL AREA + IN5 stand models	IN5 Stand-less
Model Name		K-43S30	K-43S30	K-43S30	K-43S30
SV No.		SV-42006	SV-42016	SV-42030	SV-42040
DIMENSION	TV only (W x H x D)	964 x 563 x 69 mm / 38 x 22 1/4 x 2 3/4 inch	964 x 563 x 69 mm	Approx. 964 x 563 x 69 mm	Approx. 964 x 563 x 69 mm
	TV only with camera (W x H x D)	-	-	-	-
	TV with Stand (Outside) (W x H x D)	964 x 629 x 266 mm / 38 x 24 7/8 x 10 1/2 inch	964 x 629 x 266 mm	Approx. 964 x 629 x 266 mm	-
	TV with Stand (Inside) (W x H x D)	-	-	-	-
	TV with Stand (Outside for Soundbar) (W x H x D)	-	-	-	-
	TV with Stand (Inside for Soundbar) (W x H x D)	-	-	-	-
	TV with Stand (Front position style) (W x H x D)	-	-	-	-
	TV with Stand (Back position style) (W x H x D)	-	-	-	-
	TV with Floor Stand (W x H x D)	-	-	-	-
	Stand Width (Outside)	715 mm / 28 1/4 inch	715 mm	Approx. 715 mm	-
	Stand Width (Inside)	-	-	-	-
	Stand Width (Outside for Soundbar)	-	-	-	-
	Stand Width (Inside for Soundbar)	-	-	-	-
	Stand Width (Front position style)	-	-	-	-
	Stand Width (Back position style)	-	-	-	-
Floor Stand Width	-	-	-	-	
VESA Hole Pitch	200 x 200 mm / 7 7/8 x 7 7/8 inch	200 x 200 mm	200 x 200 mm	200 x 200 mm	
WEIGHT	TV Only	9.9 kg / 21.9 lb	9.9 kg	Approx. 9.9 kg	Approx. 9.9 kg
	TV with Stand (Outside)	10.1 kg / 22.3 lb	10.1 kg	Approx. 10.1 kg	-
	TV with Stand (Inside)	-	-	-	-
	TV with Stand (Outside for Soundbar)	-	-	-	-
	TV with Stand (Inside for Soundbar)	-	-	-	-
	TV with Stand (Front/Back position style)	-	-	-	-
	TV with Floor Stand	-	-	-	-
	Floor Stand weight (Supply)	-	-	-	-
Remarks	W-M't Br. Weight (Supply)	-	-	-	-

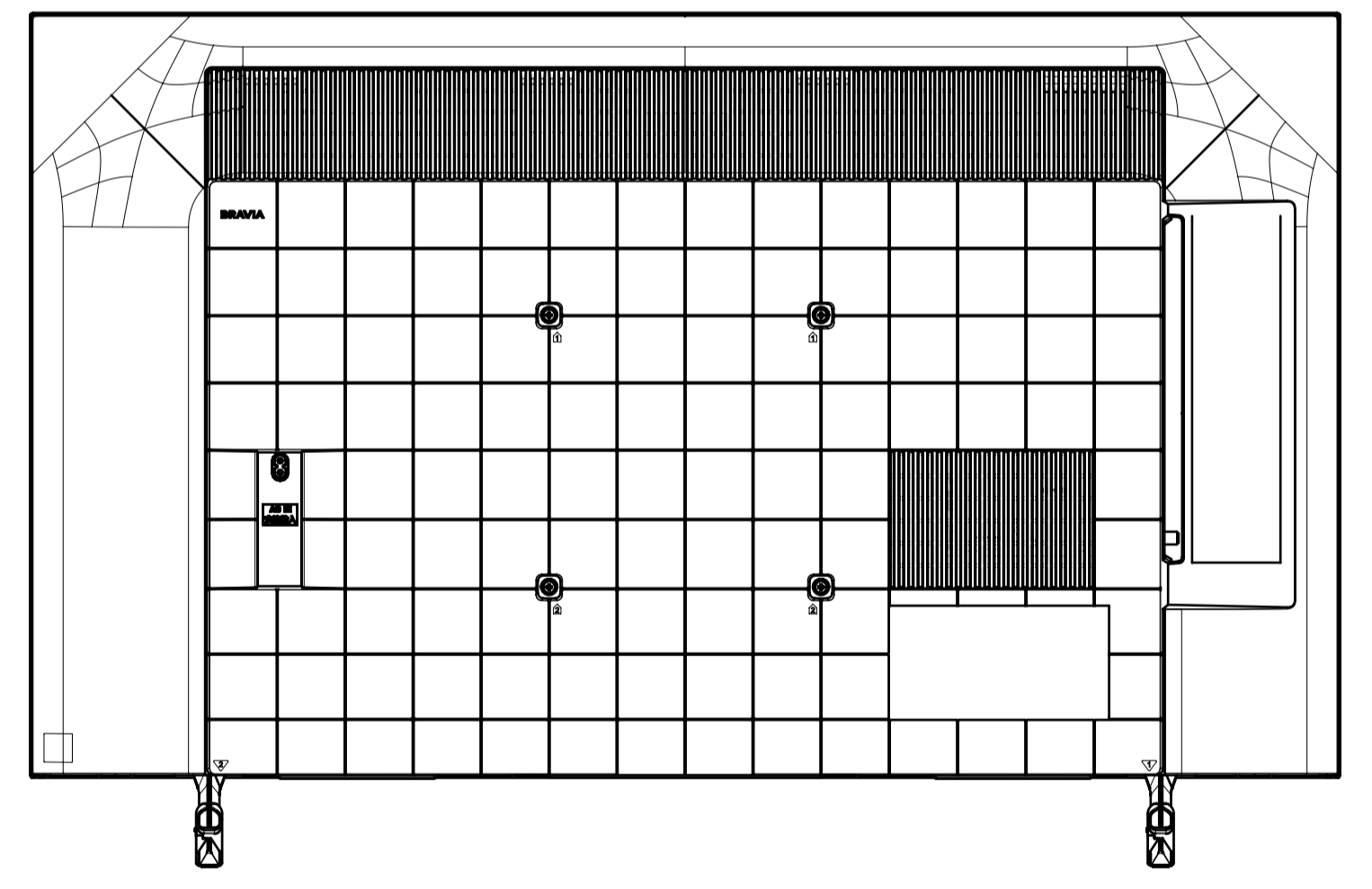
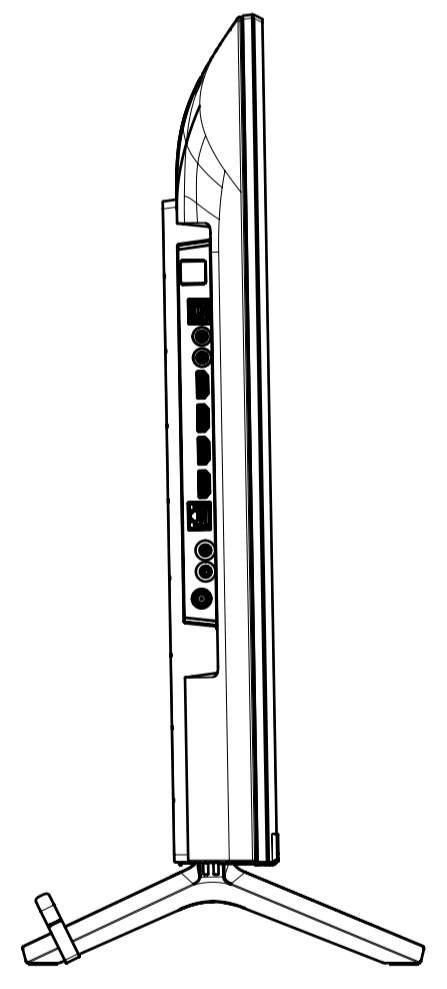
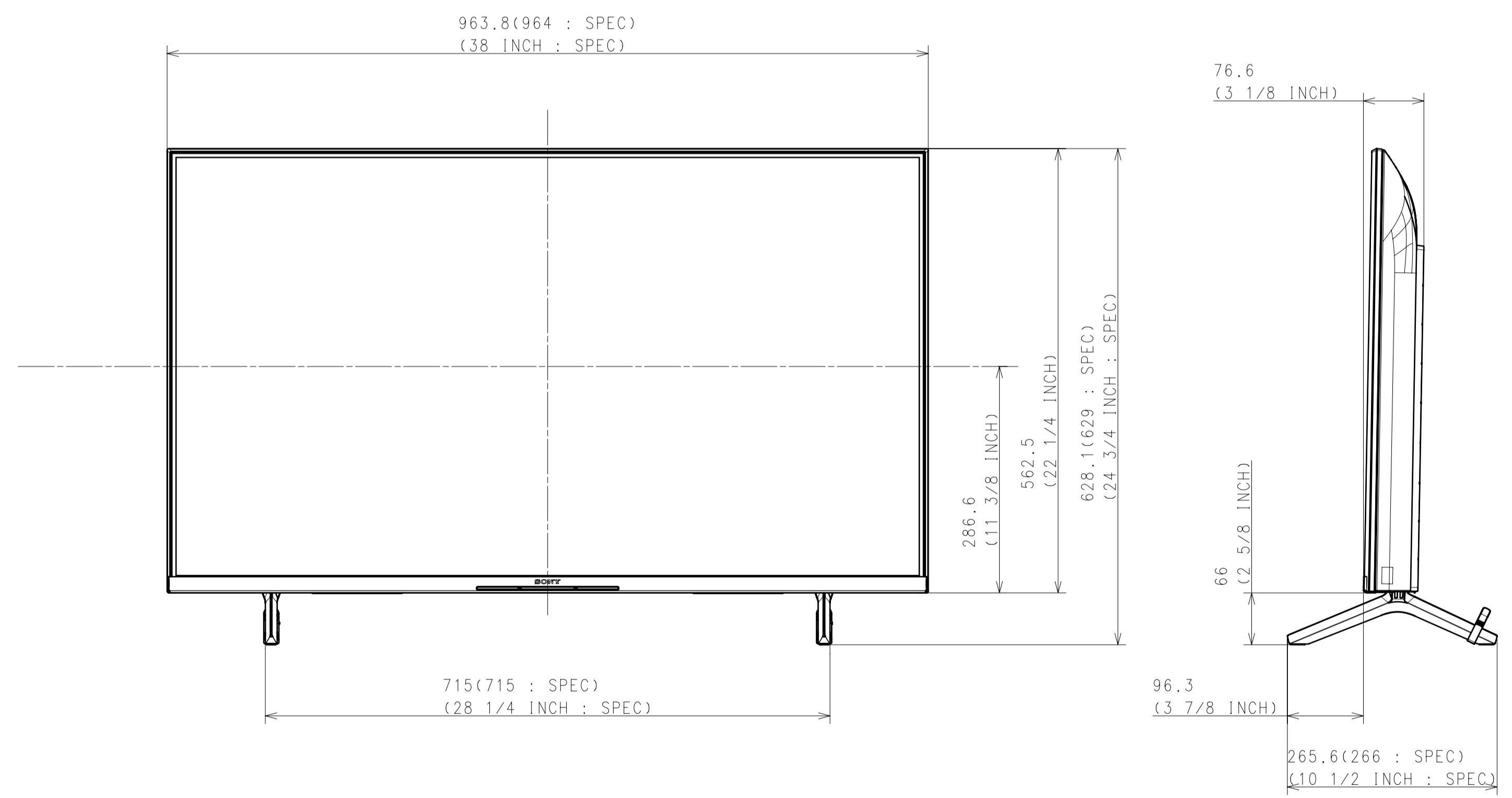
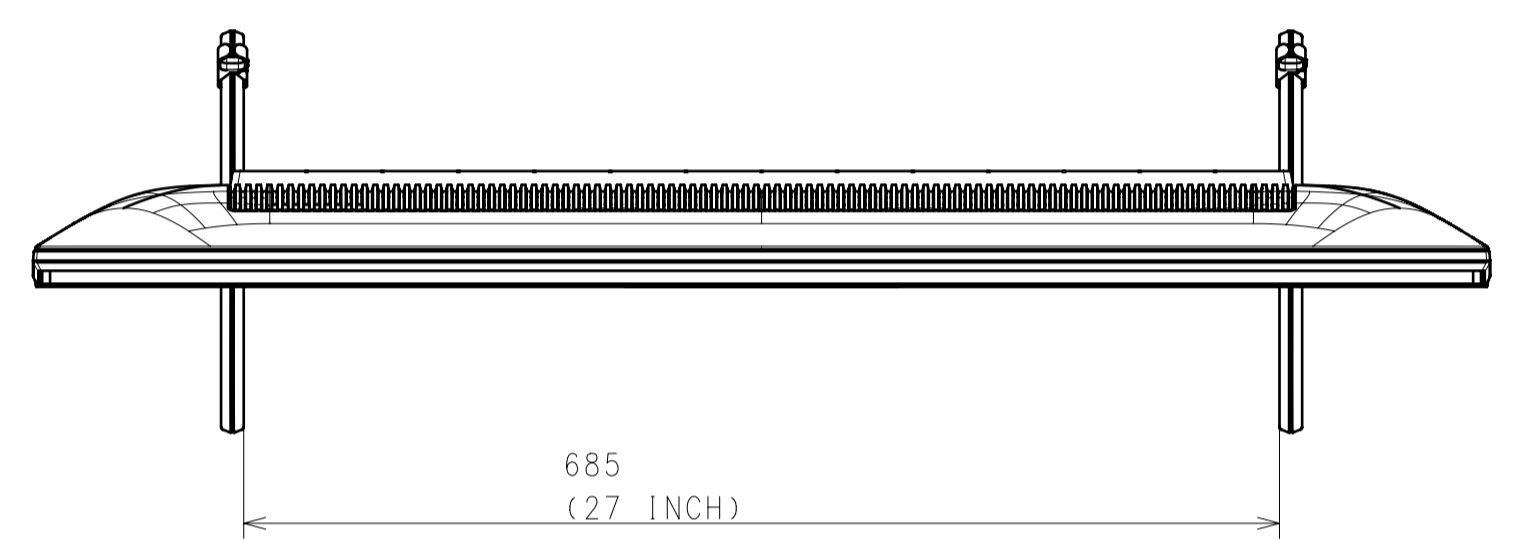

HISTORY & COUNT SUFFIX PREL. NO. REV. DATE		RELEASE NO. DATE		REVISION		SIGN.		GENERAL TOLERANCE		DATE OF ISSUE 2023.12.13 DOCUMENT TYPE ASSEMBLY TOLERANCE DRAWING (JIS & ISO/IEC 8015)	
RESPONSIBLE DEPARTMENT PLANE & MECHANICAL DESIGN		CHECKED BY DESIGNED BY 2023.11.22 HILMI - DSJ MECH		APPROVED BY SCALE 1:5		ORIGINAL MODEL TENTATIVE MODEL 43(S30) EXTERIOR VIEW		MATERIAL COLOR FINISH COLOR		DESCRIPTION 43(S30) EXTERIOR VIEW	
DRAWN BY 2023.11.22 HILMI - DSJ MECH		SIZE A1		UNIT mm		SHEET NO. 1/3		SUFFIX REV. NO.		SHEET/PAGES 1/3	

WITHOUT STAND

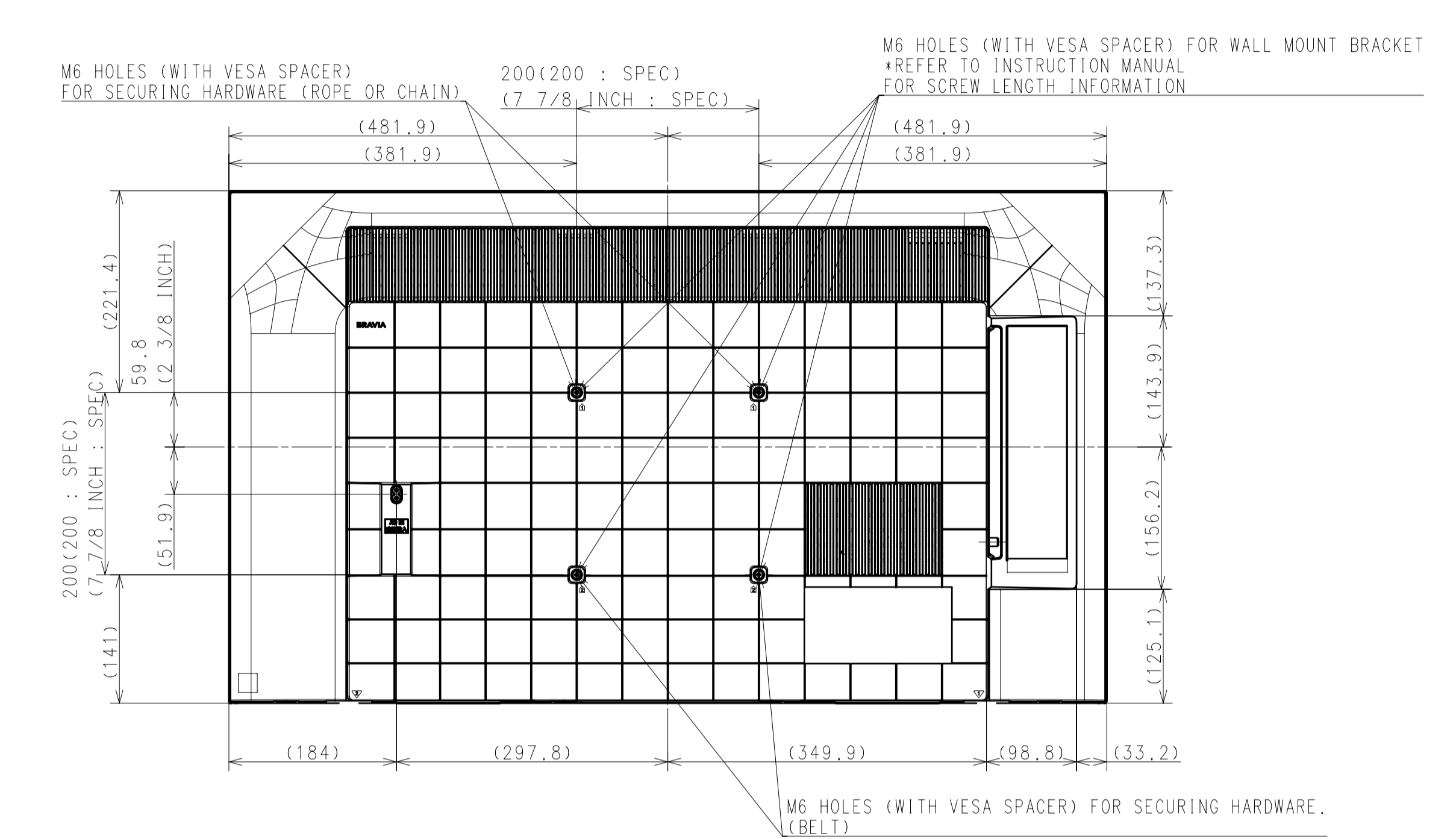
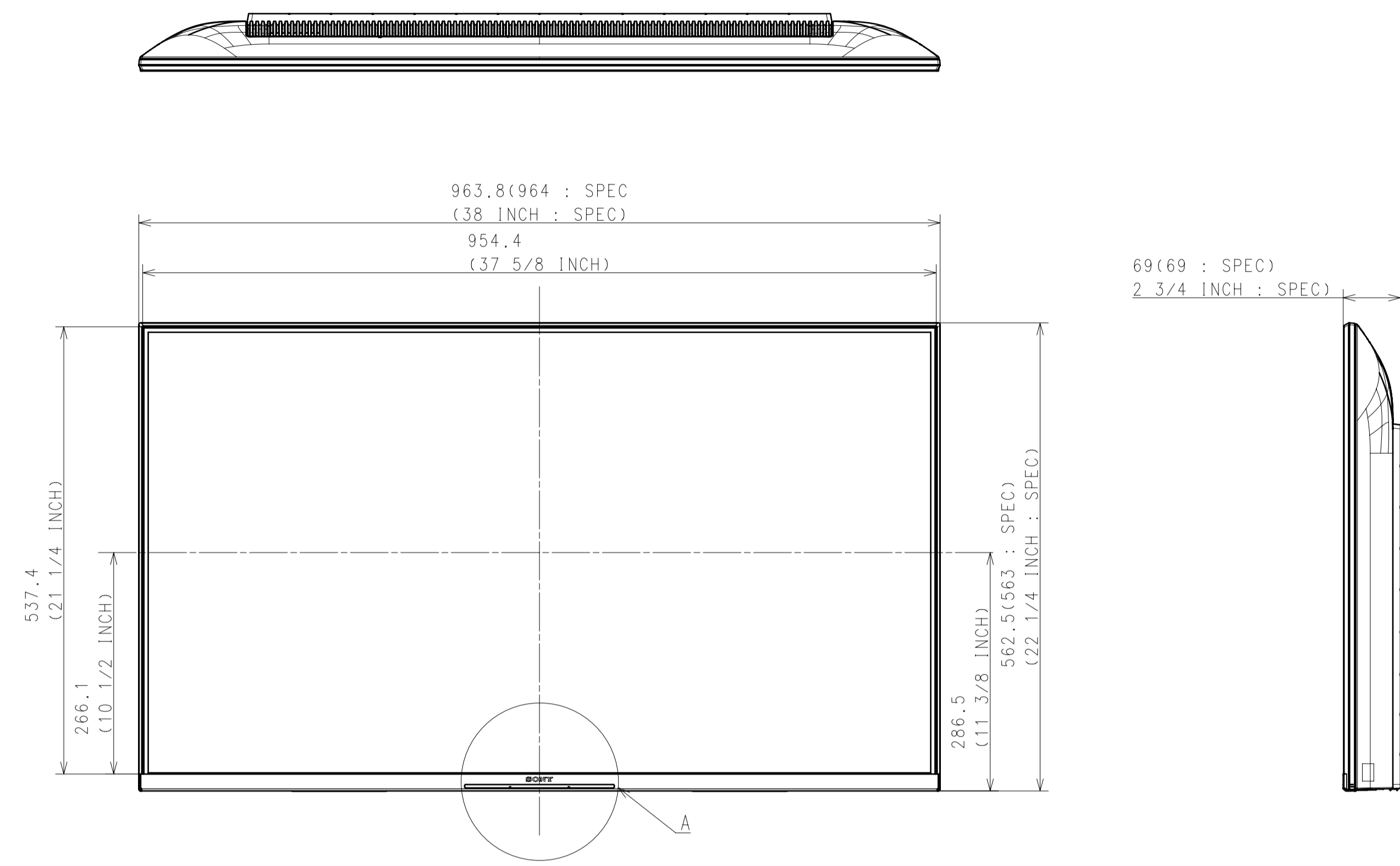

FOR GENERAL AREA, LATIN AMERICA AND NORTH AMERICA

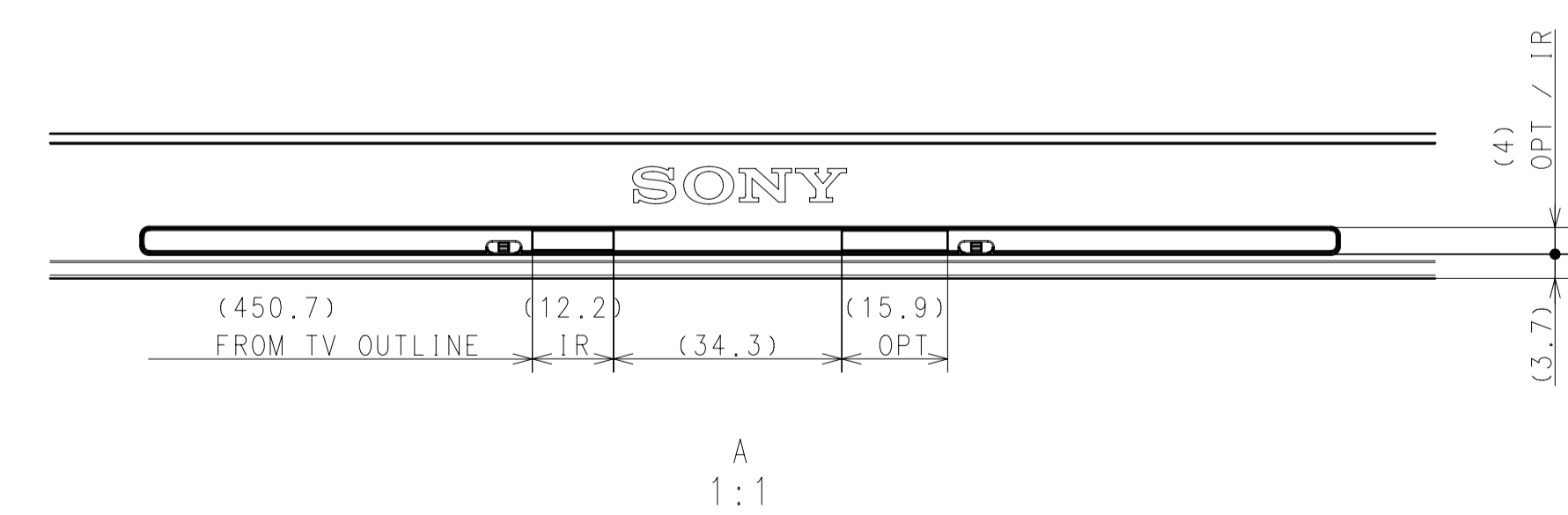
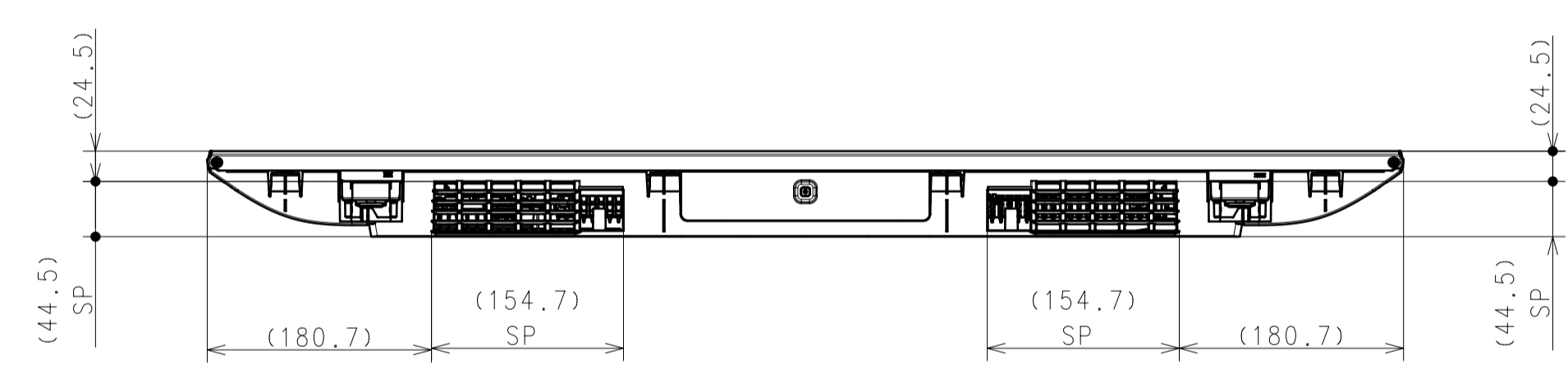

DESCRIPTION 1	43(S30) EXTERIOR VIEW	LEGAL OWNER	Sony Corporation	SCALE	T:1
DESCRIPTION 2	43(S30) EXTERIOR VIEW	PART NO.		SHEET/PAGES	2 / 3

SU-WL 450

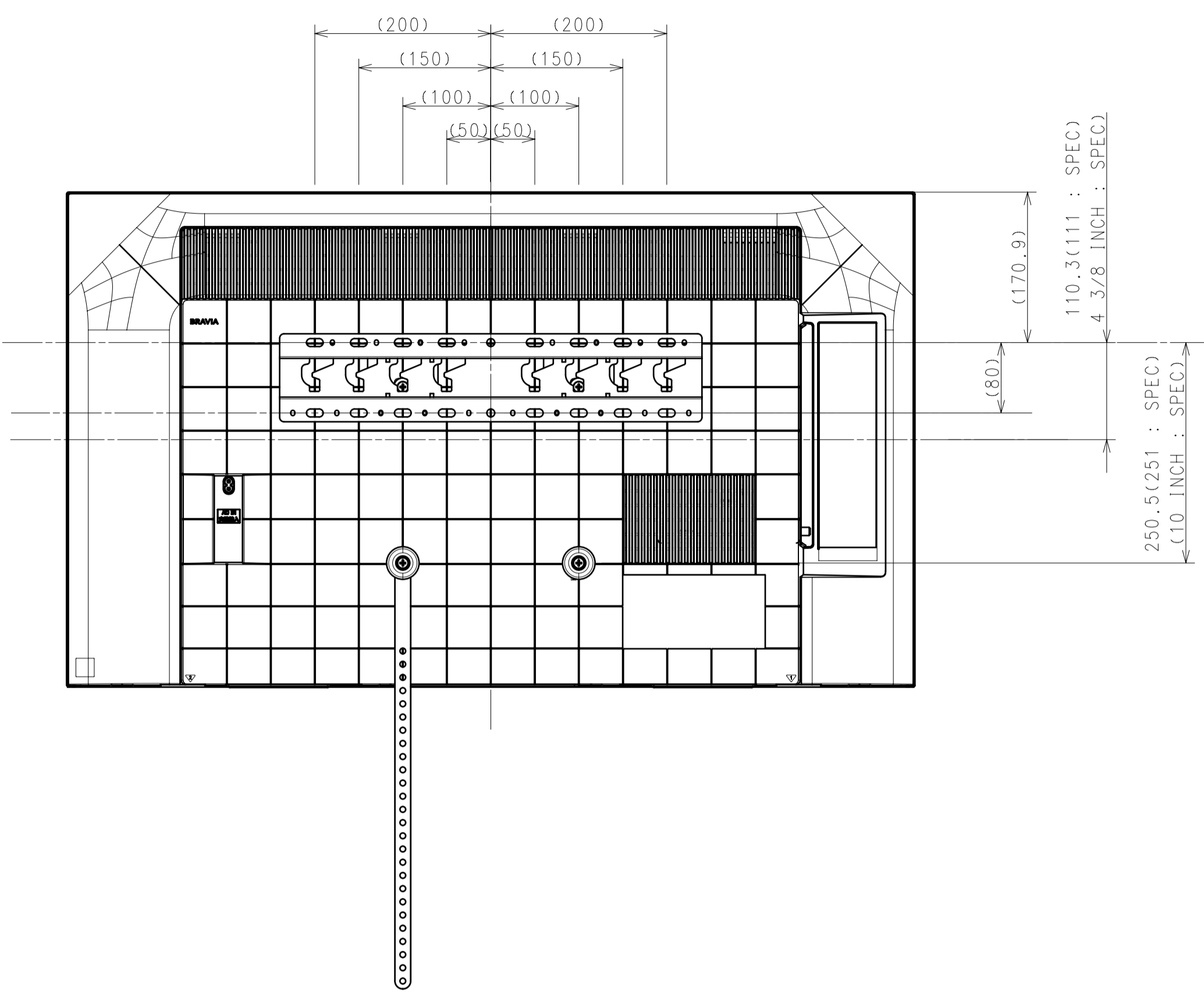

STANDARD

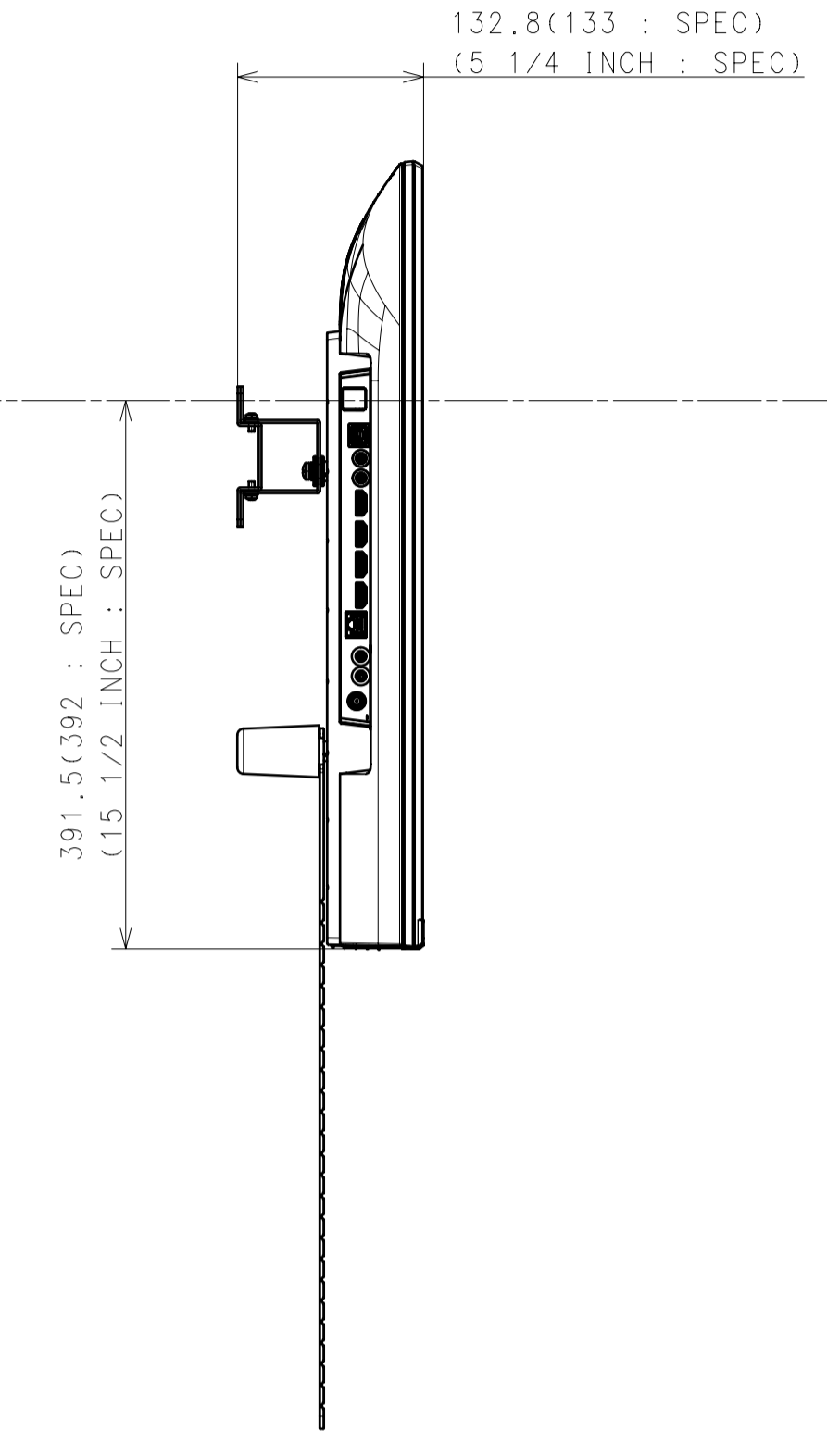

SLIM

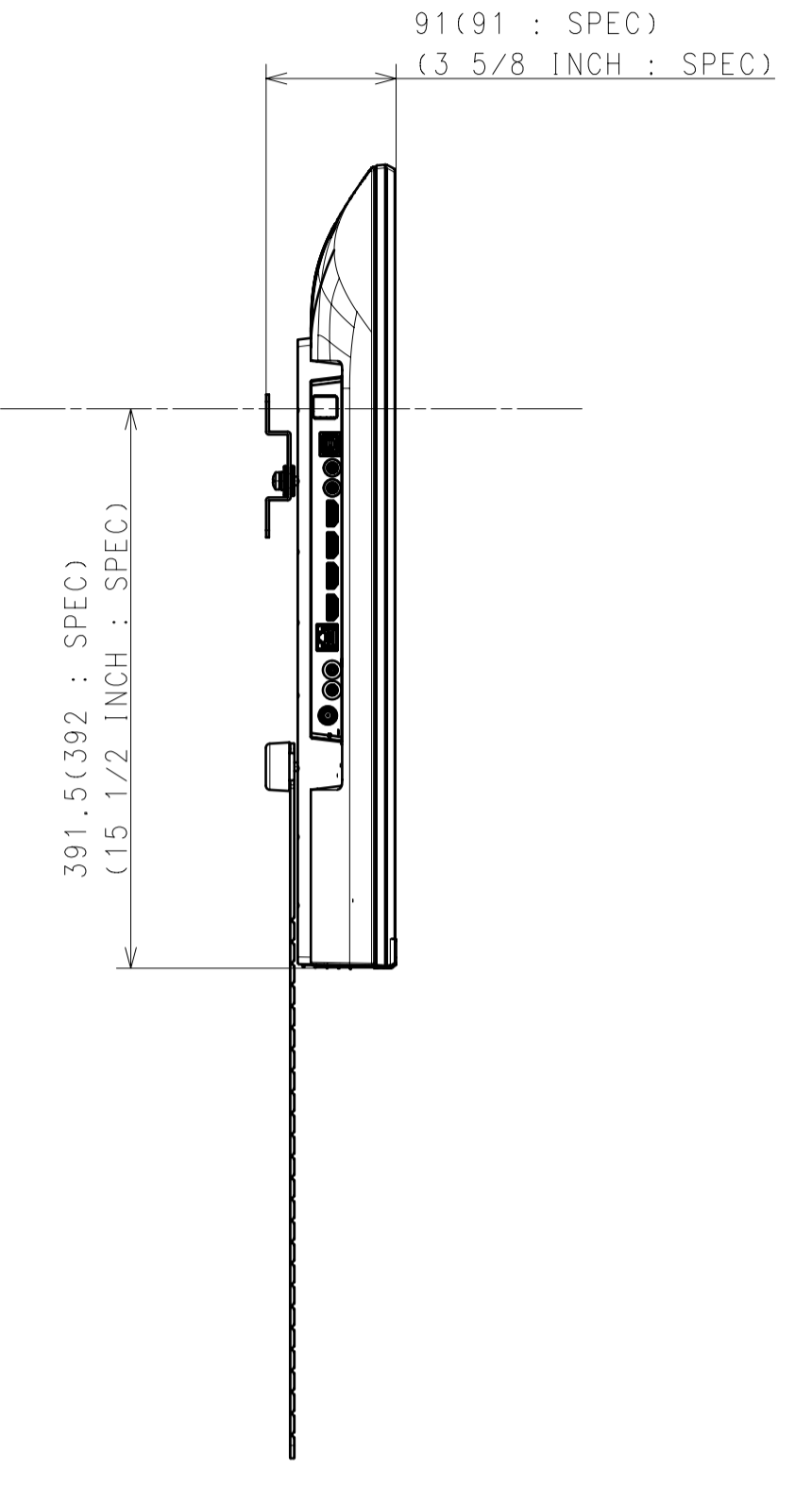

DRAWING

SONY STANDARD

DESCRIPTION 1	LEGAL OWNER	SCALE
43(S30) EXTERIOR VIEW	Sony Corporation	1:5
DESCRIPTION 2	PART NO.	SHEET/PAGES
43(S30) EXTERIOR VIEW		3 / 3